



Print Server Series

PS-1207U/PS-1208UWg

PS-1206U/PS-1206UWg

PS-1206P/PS-1206PWg

PS-3207U/PS-3207UWg

User's Manual

Version: 3.0 (July, 2007)

COPYRIGHT

Copyright ©2007/2008 by this company. All rights reserved. No part of this publication may be reproduced, transmitted, transcribed, stored in a retrieval system, or translated into any language or computer language, in any form or by any means, electronic, mechanical, magnetic, optical, chemical, manual or otherwise, without the prior written permission of this company.

Federal Communication Commission Interference Statement

This equipment has been tested and found to comply with the limits for a Class B digital device, pursuant to Part 15 of FCC Rules. These limits are designed to provide reasonable protection against harmful interference in a residential installation. This equipment generates, uses, and can radiate radio frequency energy and, if not installed and used in accordance with the instructions, may cause harmful interference to radio communications. However, there is no guarantee that interference will not occur in a particular installation. If this equipment does cause harmful interference to radio or television reception, which can be determined by turning the equipment off and on, the user is encouraged to try to correct the interference by one or more of the following measures:

1. Reorient or relocate the receiving antenna.
2. Increase the separation between the equipment and receiver.
3. Connect the equipment into an outlet on a circuit different from that to which the receiver is connected.
4. Consult the dealer or an experienced radio technician for help.

FCC Caution

This equipment must be installed and operated in accordance with provided instructions and a minimum 20 cm spacing must be provided between computer mounted antenna and person's body (excluding extremities of hands, wrist and feet) during wireless modes of operation.

This device complies with Part 15 of the FCC Rules. Operation is subject to the following two conditions: (1) this device may not cause harmful interference, and (2) this device must accept any interference received, including interference that may cause undesired operation.

Any changes or modifications not expressly approved by the party responsible for compliance could void the authority to operate equipment.

Federal Communication Commission (FCC) Radiation Exposure Statement

This equipment complies with FCC radiation exposure set forth for an uncontrolled environment. In order to avoid the possibility of exceeding the FCC radio frequency exposure limits, human proximity to the antenna shall not be less than 20cm (8 inches) during normal operation.

The antenna(s) used for this transmitter must not be co-located or operating in conjunction with any other antenna or transmitter.

R&TTE Compliance Statement

This equipment complies with all the requirements of DIRECTIVE 1999/5/EC OF THE EUROPEAN PARLIAMENT AND THE COUNCIL of March 9, 1999 on radio equipment and telecommunication terminal Equipment and the mutual recognition of their conformity (R&TTE) The R&TTE Directive repeals and replaces in the directive 98/13/EEC (Telecommunications Terminal Equipment and Satellite Earth Station Equipment) As of April 8, 2000.

Safety

This equipment is designed with the utmost care for the safety of those who install and use it. However, special attention must be paid to the dangers of electric shock and static electricity when working with electrical equipment. All guidelines of this and of the computer manufacture must therefore be allowed at all times to ensure the safe use of the equipment.

EU Countries Intended for Use

The ETSI version of this device is intended for home and office use in Austria, Belgium, Denmark, Finland, France, Germany, Greece, Ireland, Italy, Luxembourg, Bulgaria, Cyprus, Czech Republic, Estonia, Hungary, Latvia, Lithuania, Malta, Poland, Romania, Slovakia, Slovenia, the Netherlands, Portugal, Spain, Sweden, and the United Kingdom.

The ETSI version of this device is also authorized for use in EFTA member states: Iceland, Liechtenstein, Norway, and Switzerland.

EU Countries Not intended for use

None.

DISCLAIMER

This company makes no representations or warranties, either expressed or implied, with respect to the contents hereof and specifically disclaims any warranties, merchantability or fitness for any particular purpose. Any software described in this manual is sold or licensed "as is". Should the programs prove defective following their purchase, the buyer (and not this company, its distributor, or its dealer) assumes the entire cost of all necessary servicing, repair, and any incidental or consequential damages resulting from any defect in the software. Further, this company reserves the right to revise this publication and to make changes from time to time in the contents hereof without obligation to notify any person of such revision or changes.

Contents

1.	<i>Introduction</i>	1
1.1	Product Introduction.....	1
1.2	Product Package	2
1.3	Network Printing Architecture	3
1.3.1	Print Server Network Functions	4
1.3.2	Network Printing Functions for Clients.....	5
1.3.3	Network Printing Functions for Network Server.....	7
1.4	Network Printing Environment	8
1.5	Contents of the User's Manual	10
1.6	Firmware & Printing Function	11
2.	<i>Hardware Installation</i>	12
3.	<i>Windows Peer-to-Peer Network</i>	13
3.1	System Architecture.....	13
3.2	EZMax Installation Wizard	15
3.3	Administrator Utilities	23
3.4	Client Installation and Setup	24
3.5	Client Utilities	29
3.5.1	Network Ports Quick Setup.....	30
3.5.2	Remote Ports (Utility)	32
3.6	Windows Add Printer Procedure.....	34
3.6.1	Windows Vista	34
3.6.2	Windows XP	38
4.	<i>Windows NT/2000/2003 Network</i>	42
4.1	System Architecture.....	42
4.2	Windows NT/2000/2003 Server Installation and Setup .	43
4.3	User Installation and Setup.....	45
5.	<i>NetWare Network</i>	46
5.1	System Architecture.....	46
5.2	NetWare 3.x/4.x/5.x Installation & Setup	48
5.2.1	Installation Using PCONSOLE	48

6.	<i>UNIX System Network</i>	52
6.1	Introduction	52
6.2	Enable Print Server's TCP/IP Support.....	53
6.3	Setup Print Server's IP Address	53
6.3.1	DHCP	53
6.3.2	BOOTP	54
6.4	Verify Print Server's IP Address	56
6.5	Configure Remote LPD Printing on the Host	56
7.	<i>Configuration Utility</i>	59
7.1	Introduction	59
7.2	Search for All Available Print Server.....	61
7.3	Status of Print Server.....	62
7.4	Setup the Print Server	63
7.5	General Configuration.....	64
7.6	TCP/IP Configuration.....	65
7.7	Netware Print Server Configuration	67
7.8	AppleTalk Configuration	68
7.9	SNMP Configuration	69
7.10	SMB Configuration.....	70
7.11	System Configuration	71
7.12	Wireless Configuration.....	73
7.13	Wizard.....	83
7.14	Report	88

8.	<i>Web Management</i>	89
8.1	Introduction	89
8.2	Login	90
8.3	Device Status	91
8.3.1	System	91
8.3.2	Printer	92
8.3.3	TCP/IP	93
8.3.4	SMB	94
8.3.5	SNMP	95
8.3.6	NetWare	96
8.3.7	AppleTalk	97
8.4	Setup Wizard	98
8.4.1	System	98
8.4.1.1	Advanced Settings	99
8.4.2	Wireless	100
8.4.2.1	General Setting	100
8.4.2.2	Encryption	103
8.4.2.3	Site Survey	106
8.4.3	TCP/IP	108
8.4.4	SMB	109
8.4.5	SNMP	110
8.4.6	NetWare	111
8.4.7	AppleTalk	113
8.4.8	Save Settings	114
8.5	System Tools	115
8.5.1	Load Default	115
8.5.2	Upgrade Firmware from Browser	116
9.	<i>IPP Printing</i>	117
9.1	Introduction	117
9.2	System Setup	117
9.2.1	Print Server Side	117
9.2.2	Client Side	118

10. <i>LPR Printing</i>	123
10.1 Introduction	123
10.2 Standard LPR Settings in Windows XP	124
10.3 Standard LPR Settings in Windows Vista	131
10.4 Standard LPR Settings in MAC OS 10.x	138
10.4.1 MAC 10.4.....	138
10.4.2 MAC 10.4.....	139
11. <i>Windows XP SP2 Setup</i>	143

1. Introduction

1.1 Product Introduction

Thank you for purchasing and using our print server. This print server allows your printer to become a shared device on the network. It offers printing flexibility and manageability on your Local Area Network at an extremely low cost and with an absolute minimum setup and maintenance required.

This print server provides IEEE 802.11g/b wireless LAN (up to 54Mbps data transfer rate), an Ethernet network port (10/100Mbps Ethernet) and one print port for printer.

This print server supports IPX/SPX, NetBEUI, TCP/IP and AppleTalk protocols. It is the best network printing solutions for various common network operating systems such as Windows 98SE/Me/NT/2000/XP/2003/Vista, NetWare, Unix/Linux and MAC OS, etc.

With the help of Installation Wizard, you can easily and instantly complete the settings for the printing environment, and start enjoying the fantastic features provided by the print server.

In the following chapters, we will introduce in detail the printing features, installation methods, and system configuration for different network environments.

If you would like to set up and install print server quickly, please refer to the Quick Installation Guide that comes along with this print server.

1.2 Product Package

This package contains the following components:

- One Print Server
- One Antenna
- One Power Adapter
- One Quick Installation Guide
- One CD-ROM (Including all the software utilities,
drivers and User's Manual)

1.3 Network Printing Architecture

This section illustrates how print server functions and operates on the network. Before you install and use print server, it is strongly recommended that you read this section completely, and select only the chapters you need according to your network operating system by “Contents of the User’s Manual” in next section.

This section will first introduce the role every component plays in the network-printing environment.

Print Server

Client User

Network Server (optional)

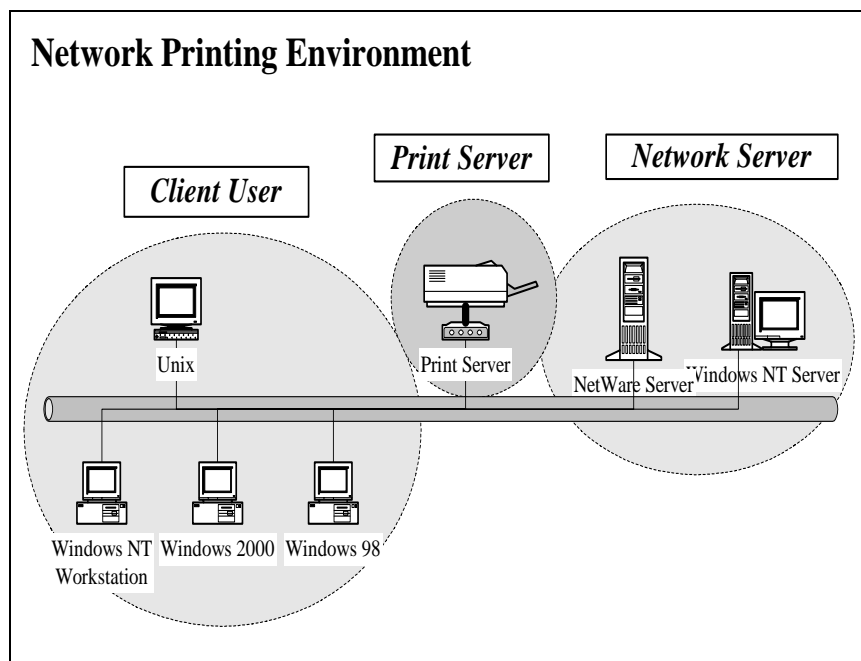

1.3.1 Print Server Network Functions

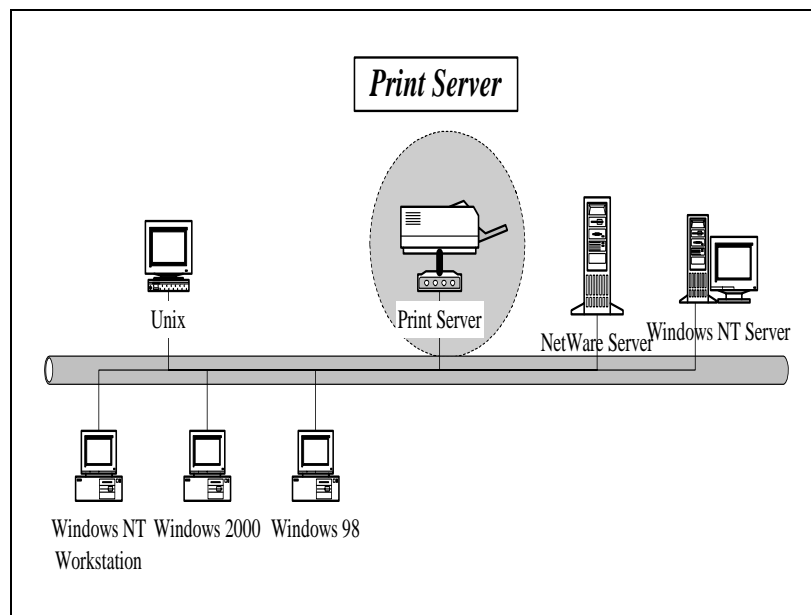

Because print server supports IPX/SPX, NetBEUI, TCP/IP and AppleTalk network protocols, any networked computer can directly print to the print server from any of its installed protocol.

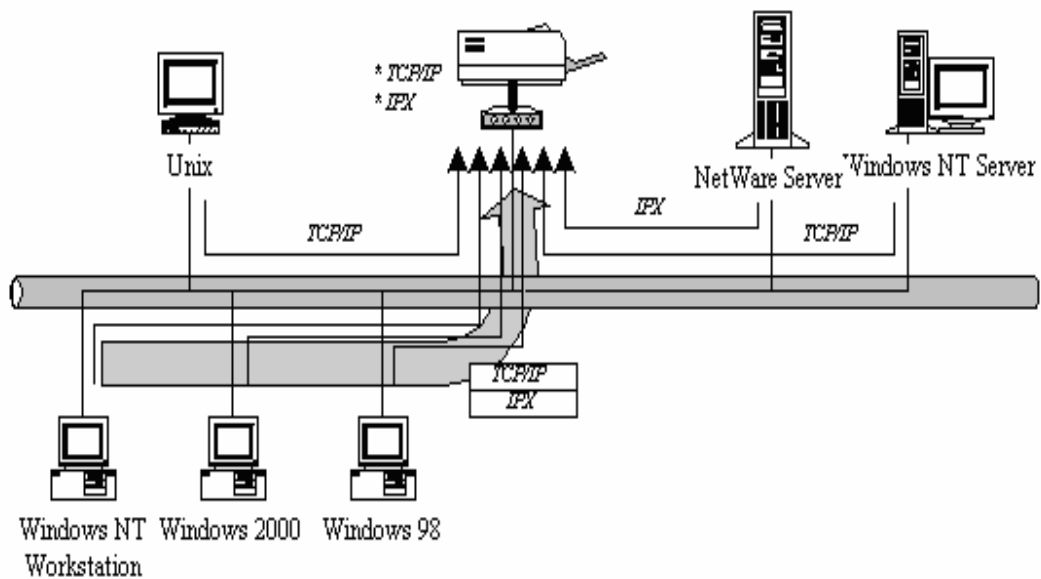

1.3.2 Network Printing Functions for Clients

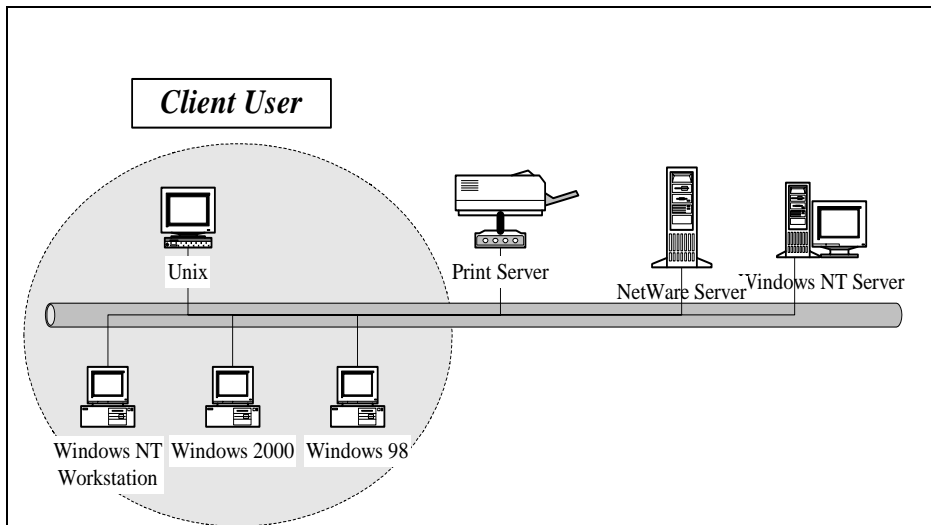

Common operating systems for clients are classified as following:

Windows 98SE/Me/NT/2000/XP/2003/Vista

Our print server system provides PTPP (Peer-to-Peer Printing) driver and utilities for Windows 98SE/Me/NT/2000/XP/2003/Vista users. PTPP (Peer-to-Peer Printing) supports TCP/IP protocol.

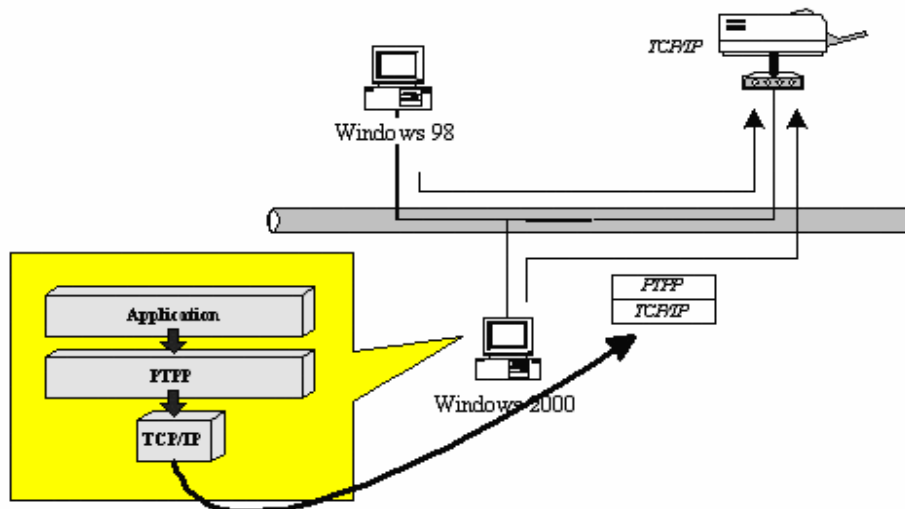

In the client installation procedure, after PTPP (Peer-to-Peer Printing Driver) is installed into Windows, the system will automatically (manual configuration is also allowed) search all the print servers on the network, and then add their printing ports into Windows' printing port (see below).

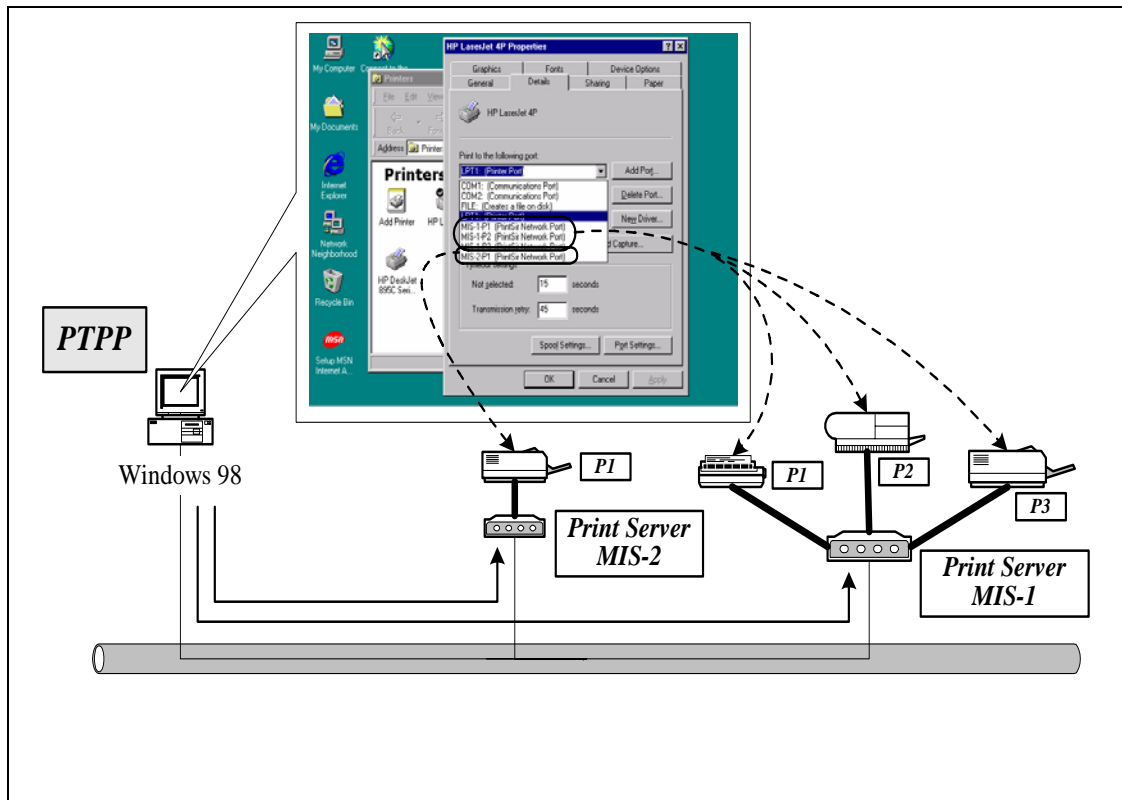

UNIX / Linux

UNIX (include HP/UX, SCO Unix, SunOS, Solaris, Unixware DECUnix, IBM AIX and others) and Linux use the system-standard LPR to print through print server.

MAC OS

MAC OS can use the system-standard AppleTalk network to print through print server.

1.3.3 Network Printing Functions for Network Server

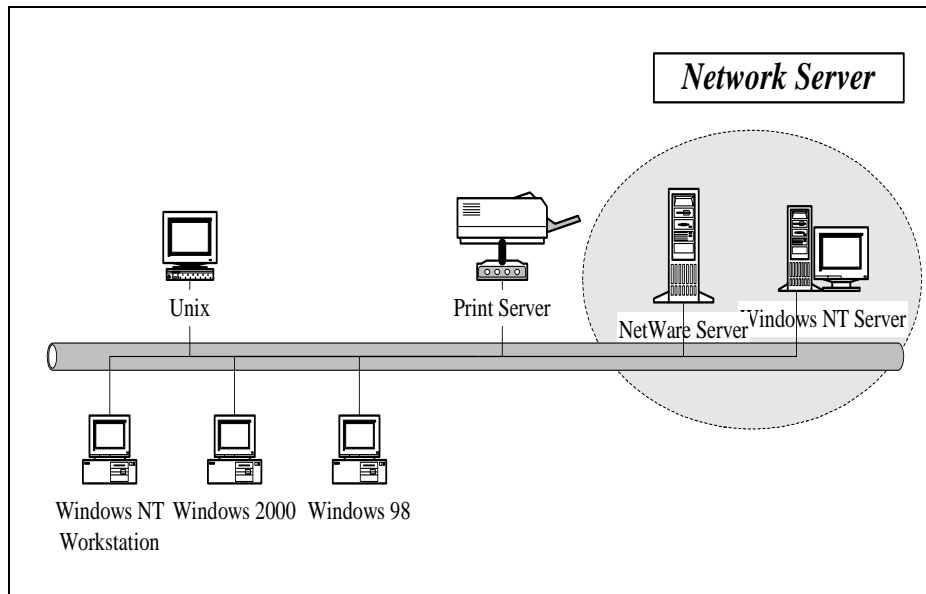

Common network servers are classified as following:

Windows NT/2000/2003

Our print server system provides PTPP (Peer-to-Peer Printing) driver and utilities for Windows NT/2000/2003. After PTPP is installed, the server can directly print through print server. Adding this printing function into Windows NT/2000/2003 Server allows print queue, user authority management, and many other advanced features to be used.

NetWare 3.x/4.x/5.x

In NetWare environment, print server offers various printing modes like print queue, remote printer, etc.

1.4 Network Printing Environment

Common network environment are classified as following:

Windows Peer-to-Peer Network

The client's PTPP driver will use TCP/IP protocol to print through print server.

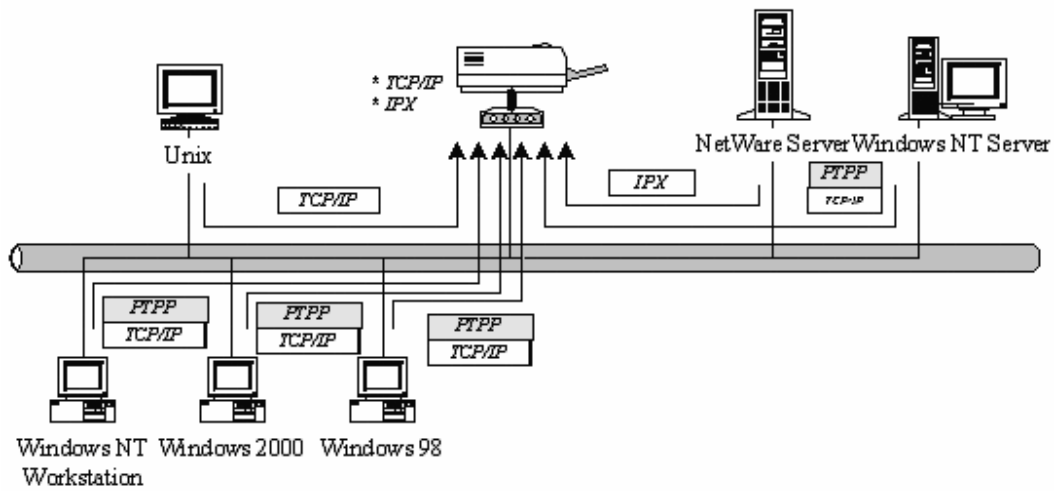

Windows NT/2000/2003 Network

Network printing function will become available after PTPP driver is installed into Windows NT/2000/2003. Adding this printing function into Windows NT/2000/2003 Server allows print queue, user authority management, and many other advanced features to be used.

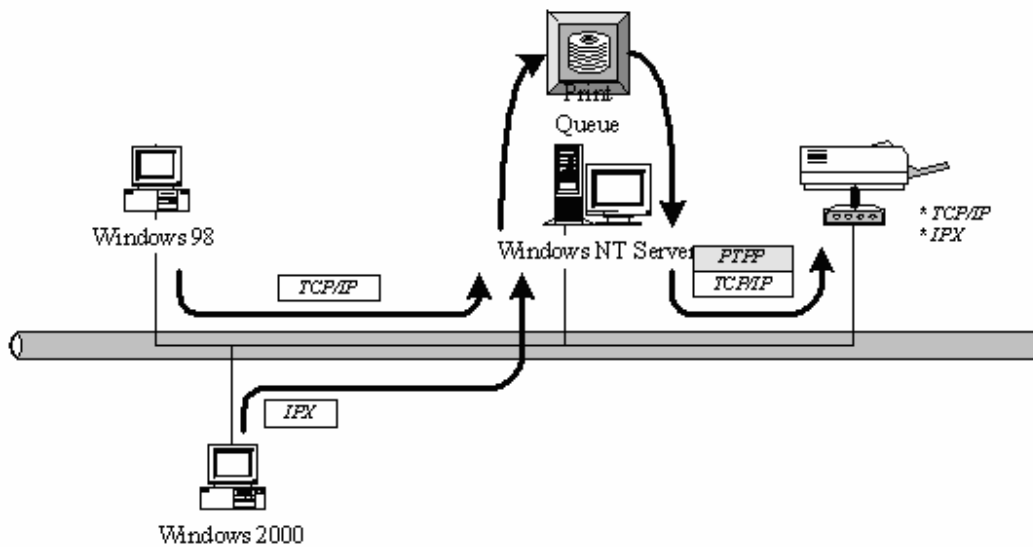

NetWare Network (see below)

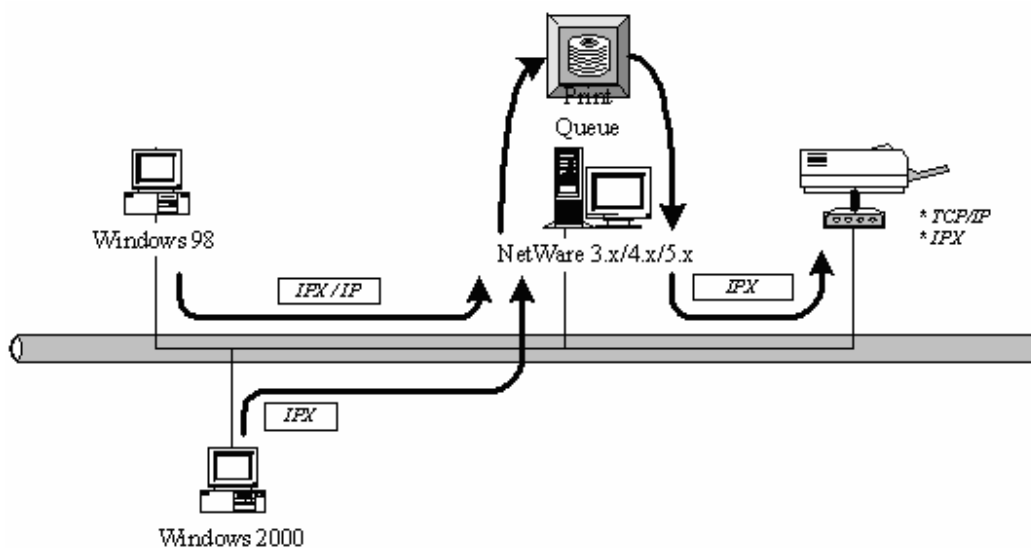

1.5 Contents of the User's Manual

Chapter 2. explains print server's hardware installation and configuration. It is strongly recommended for you to read.

The following chapters introduce:

Chapter 3. Windows Peer-to-Peer Network

Chapter 4. Windows NT/2000/2003 Server-Based Network

Chapter 5. NetWare Network

Chapter 6. UNIX System Network

You may select the appropriate chapters and sections to read depending on your network printing's requirement.

Chapter 7. and chapter 8 introduce print server's management and configuration utilities on Windows and Web Browser's environment respectively. You may select the appropriate management utility according to the administrator's computer platform.

Chapter 9. introduces Print Server's IPP Printing function and setup procedure. The IPP Printing provides a convenient way to print documents across the Internet by the IPP protocol.

Chapter 10. introduces Print Server's LPR Printing function and Windows XP/Vista and MAC OS 10.x standard setup procedures. The LPR Printing (Line Printer Remote technology) allows users to connect to printers via TCP/IP for printing sharing.

Chapter 11. introduces how to deal with the problem that if you can't find any print server listed on the "Available Ports" in "Network Ports Quick Setup" in Windows XP SP2.

1.6 Firmware & Printing Function

The print server provides a complete network printing solution. The feature set is listed below:

- PTPP (Peer-to-Peer-Printing)
- TCP/IP (LPR)
- IPP Printing
- NetWare Bindery Printing
- AppleTalk
- SMB Printing

2. Hardware Installation

Unpack the print server package and verify that all the items listed in the section 1.2 are provided.

Connect the print server to the printer you want to share on the network.

Connect the print server to your network by attached the network cable to the UTP port of the print server.

Connect the power adapter to the print server. The print server will perform the Power-On-Self-Test (POST) after it is powered on. During the POST, the Status and Ready LEDs will be on. When the LEDs are unlighted, the print server is ready.

NOTE1: MUST use the power adapter shipped with the print server, do NOT use any other power adapter from any sources.

NOTE2: To prevent the compatibility problem between print server and a few printer, it is recommended that you power on the print server before the printer.

3. Windows Peer-to-Peer Network

3.1 System Architecture

Print server supports Windows Peer-to-Peer network printing mode, which is suitable for most medium and small network environments. Through quick and simple installation procedure, users can immediately enjoy the convenience of network printing.

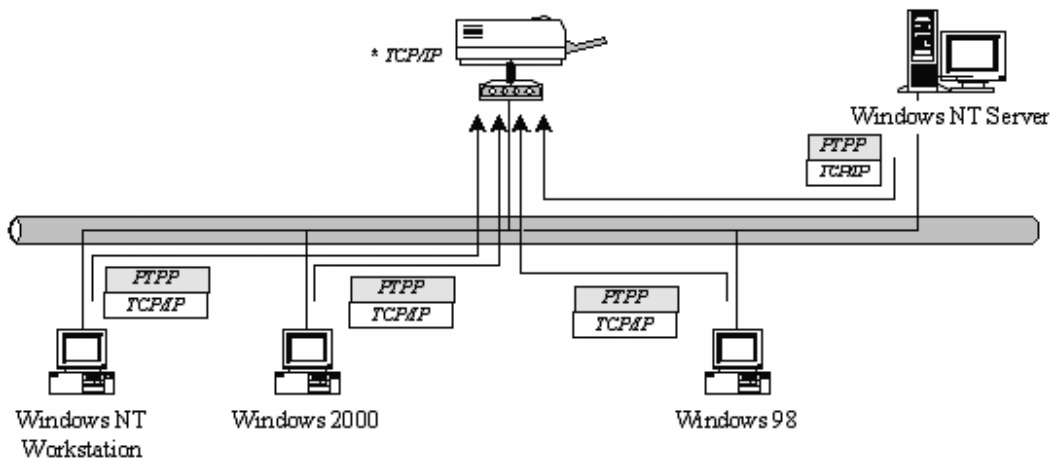

Installation procedure is separated into following two parts:

1. Administrator Installation and Setup (refer to section 2 for more detailed information).

System administrators must:

Install administrator's utilities into his/her computer.

Configure print server from administrator's configuration utility.

2. Client Installation and Configuration (refer to section 3 for more detailed information).

Client users must install Windows PTPP driver (Peer-to-Peer Printing) for network printing.

In addition, after PTPP is installed, the system will automatically search for all print servers on the network, and add the printing port of the print servers into Windows' printing port (refer to Network Printing Architecture in section 1.4 for more detailed information).

3.2 EZMax Installation Wizard

This wizard can be run in Windows 2000/XP/Vista. **The following procedures are operated in Windows XP.**

You can install the Print Server by EZMAX Setup Wizard in the CD-ROM including in the package. The wizard is an easy and quick configuration tool for internet connection with series process. When you start EZMAX Setup Wizard, you will get the following welcome screen. Please choose the language to start the configuration. The wizard will guide you to finish your network connection. We will not provide any instruction for the EZMAX Setup Wizard here.

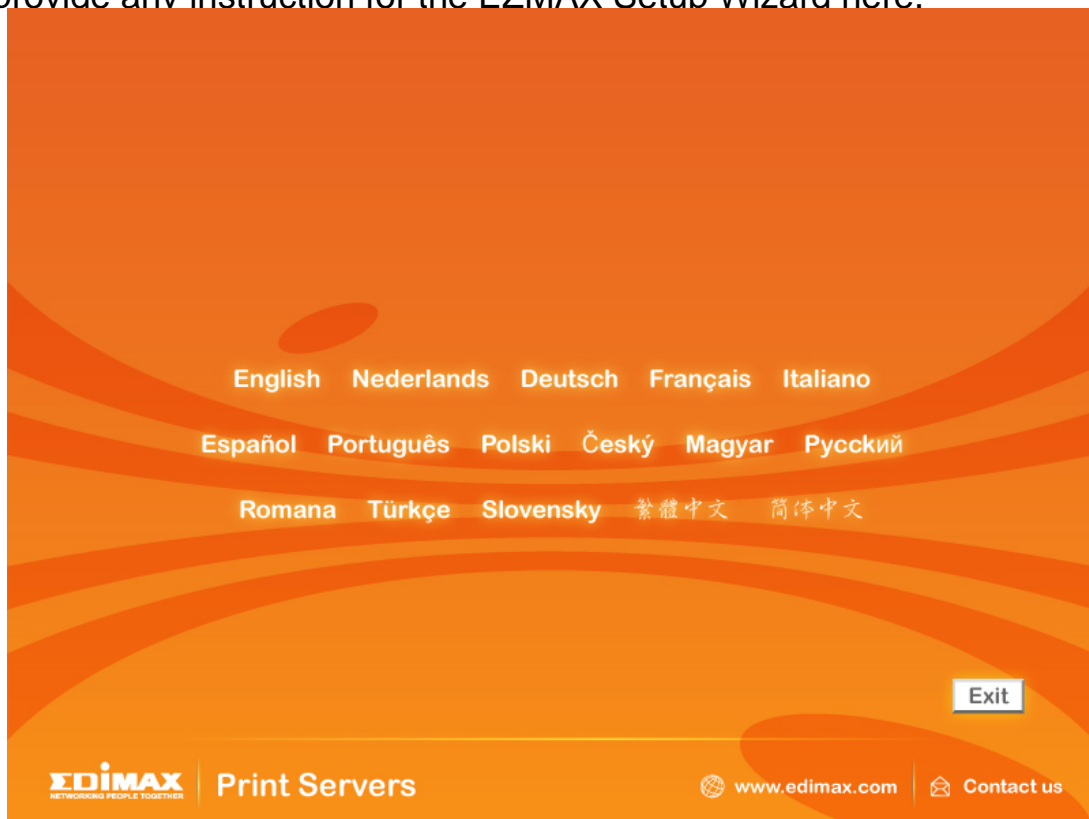

If you lose the CD ROM or you prefer the traditional setup procedure, please follow the instruction as following step in this quick installation guide.

3.3 Administrator Installation and Setup

***Please find the utility manually from CD-ROM drive's root directory or download it from Edimax webiste. If you have any question please check with Edimax local technical support team.*

The Administrator Installation Program executes a wizard-driven procedure that performs the following tasks:

- Install all necessary utilities and drivers in your PC (including the client utilities).
- Prompt to configure the print server (including the print server name and IP Address).
- Add the network port of the print server to your PC.

After the installation, perform the standard "Add Printer" procedure and choose the print server's "Network Port" in the "Available Ports" list. Then, you can test printing function from the Administrator PC.

The Administrator Installation can be performed on Windows 2000/XP/2003/Vista with the same user interface. Before the installation, please verify that your network protocol is installed on your PC (TCP/IP, IPX and/or NetBEUI). Note that the following steps are running in Windows XP, for other Operation Systems the procedures are similar.

1. Please execute the Administrator installation software manually.

2. The “Print Server Utilities” window will be displayed. Click “Next”.

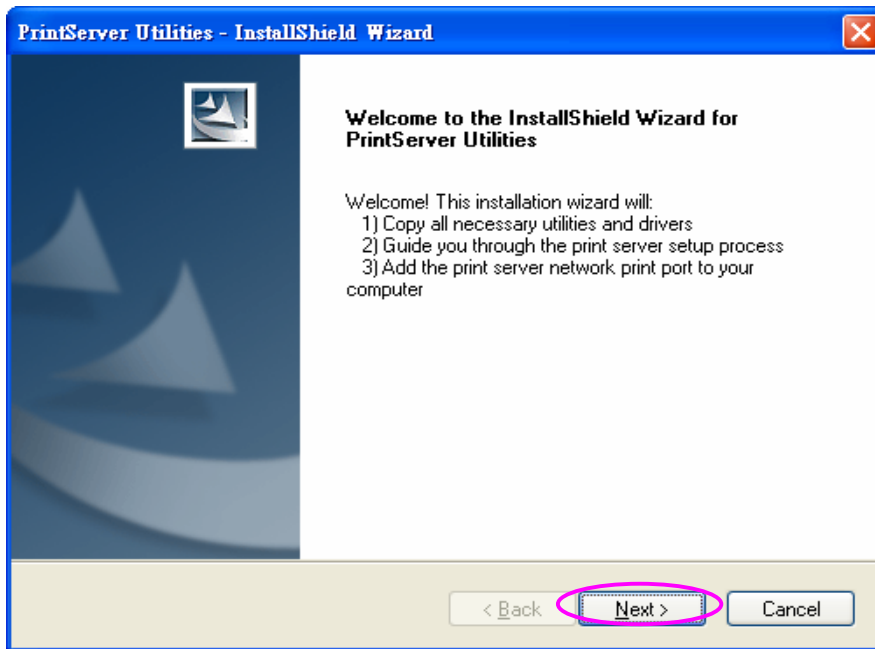

3. Click “Next” to install the utilities in the default folder or click “Change” to specify the destination folder where you would like to install the utilities.

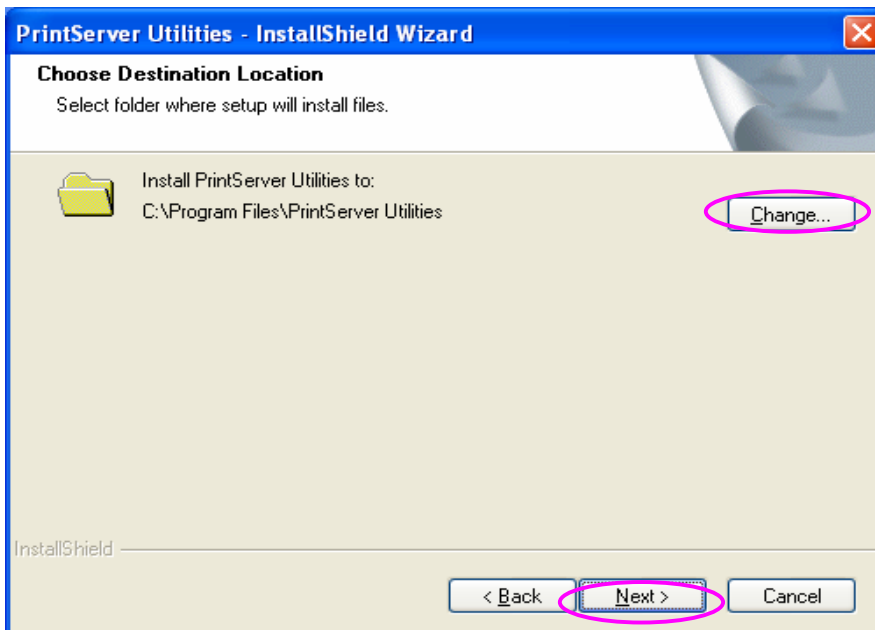

4. Select the components you want to install. It is highly recommended to install all provided components. Click “Next” to continue.

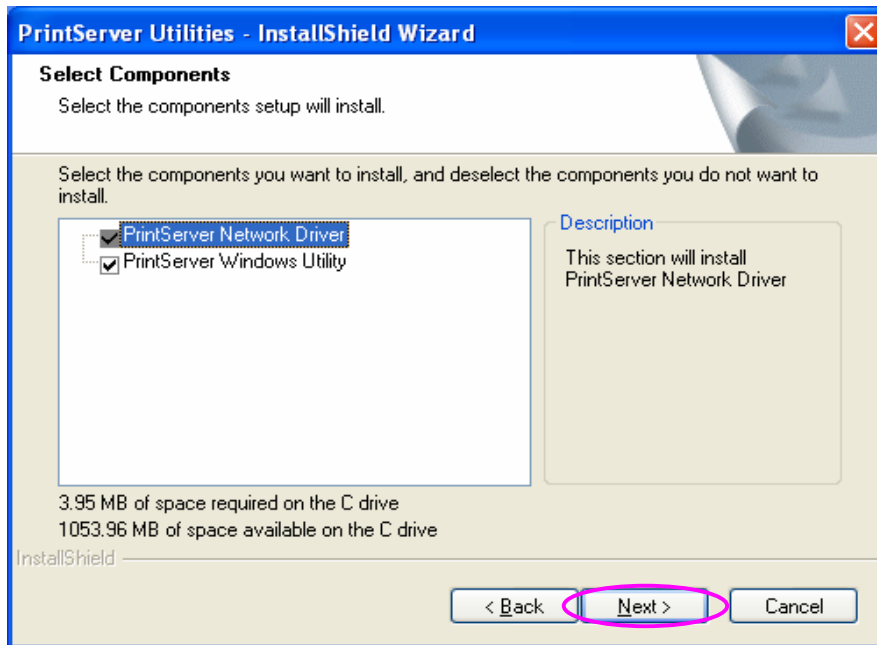

5. Click “Install”.

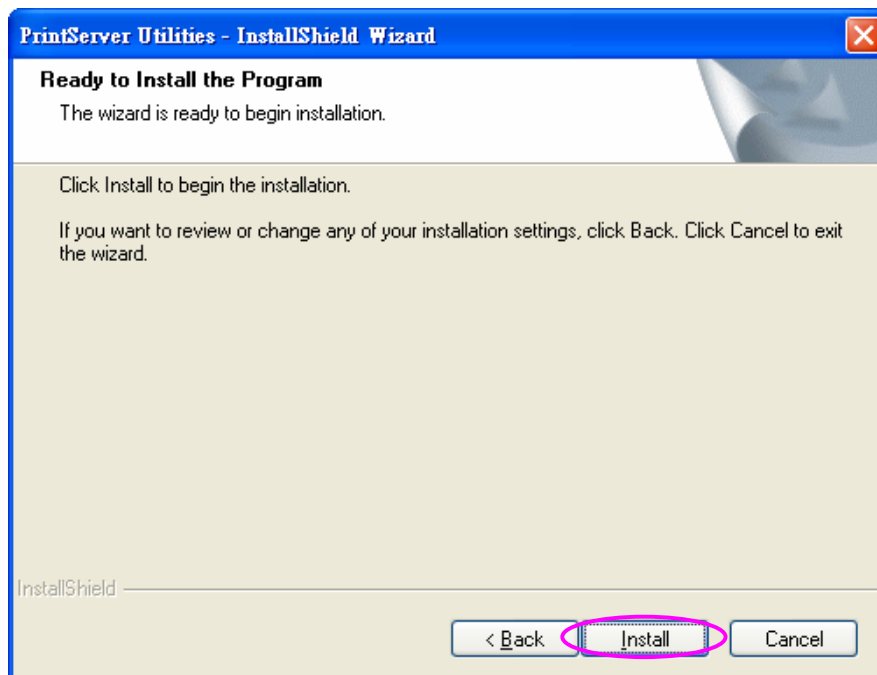

6. The system will start to install the utilities automatically.

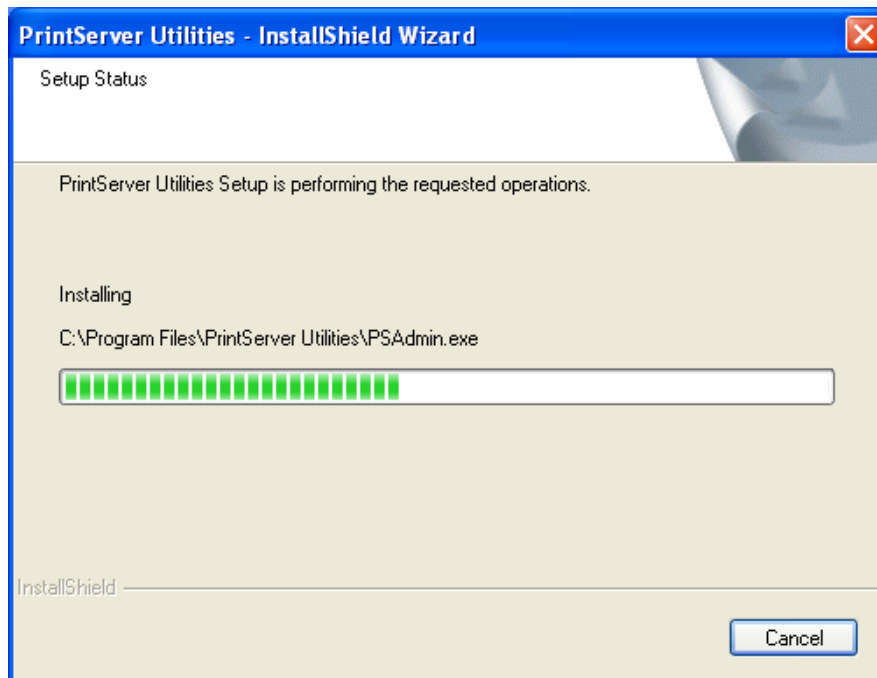

7. You have completed the installation phase and prepare to configure the Print Server. The “Choose Print Server” will list all Print Servers within the network. Select the Print Server you would like to configure and click “Next”.

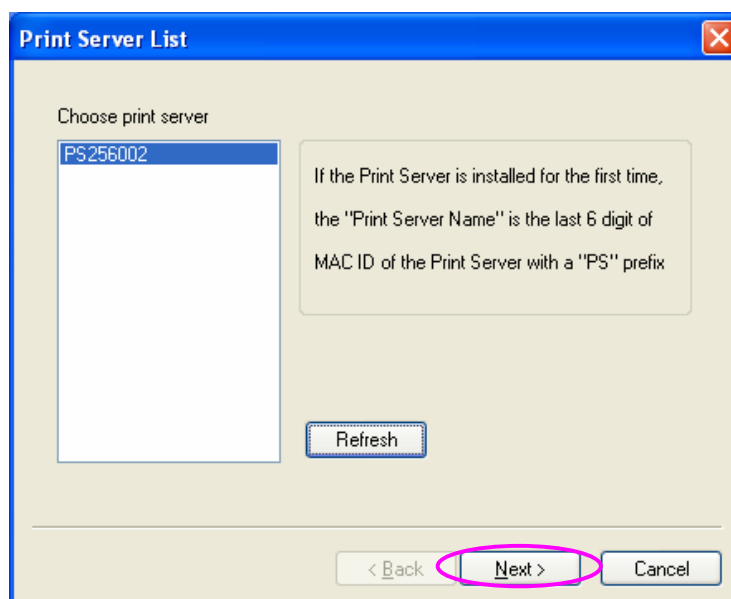

NOTE 1:

If this is the first time you configure the Print Server, the “Print Server Name” is the last 6-digit of MAC ID with prefix “PS”. Please check the MAC ID on the print server.

NOTE 2:

The list can only display the devices from Ediamx.

8. Specify a recognizable name for the Print Server and click “Next”.

The screenshot shows a dialog box titled "Name the Print Server". It has a blue title bar with a close button in the top right corner. The main area is light beige. There are two input fields: "Device name" containing "PSCA82F3" with the text "The unique serial number of the print server" below it, and "Alias Name" containing "PS256002" with the text "An alternative name for easy management" below it. At the bottom, there are three buttons: "< Back", "Next >" (which is circled in pink), and "Cancel".

- Specify the IP Address for the Print Server manually or click “Next” to keep default IP Address, i.e. 192.168.2.2.

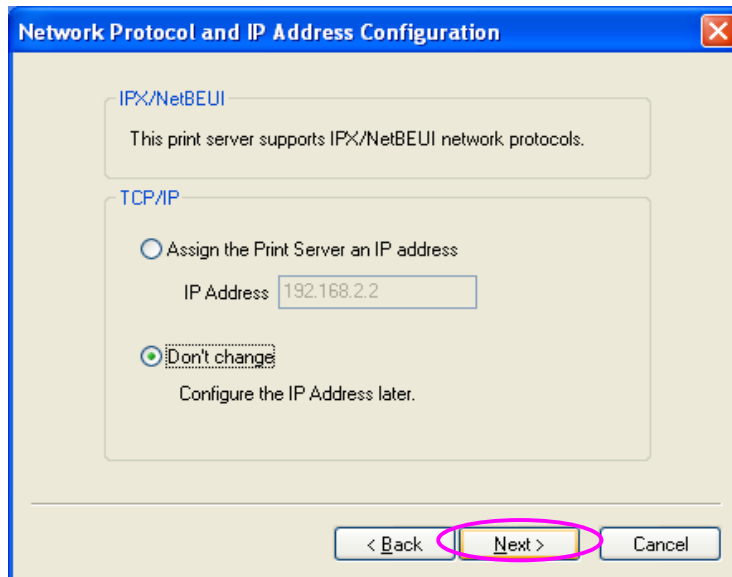

- The configuration summary is displayed in the window. Now, you have completed the Print Server setup. Click “Finish” and your system will add network port of the Print Server to your PC automatically.

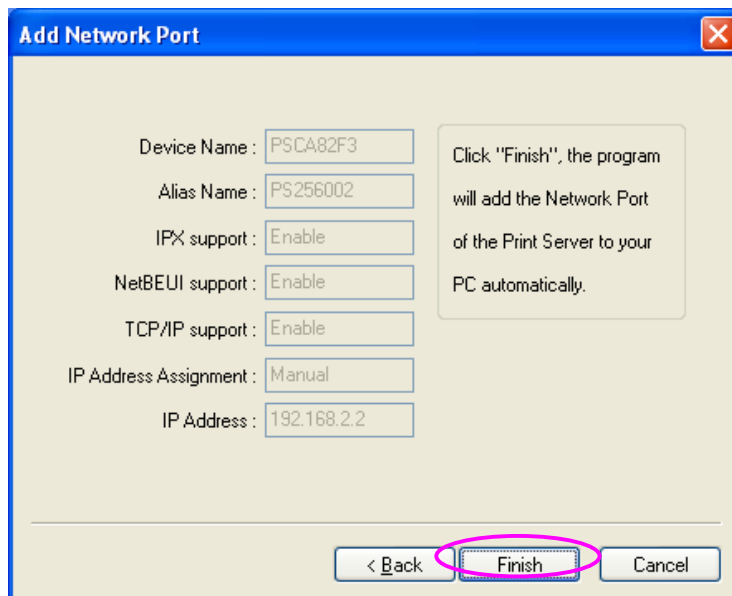

11. The Administrator Installation procedure is totally completed. Click “Finish”.

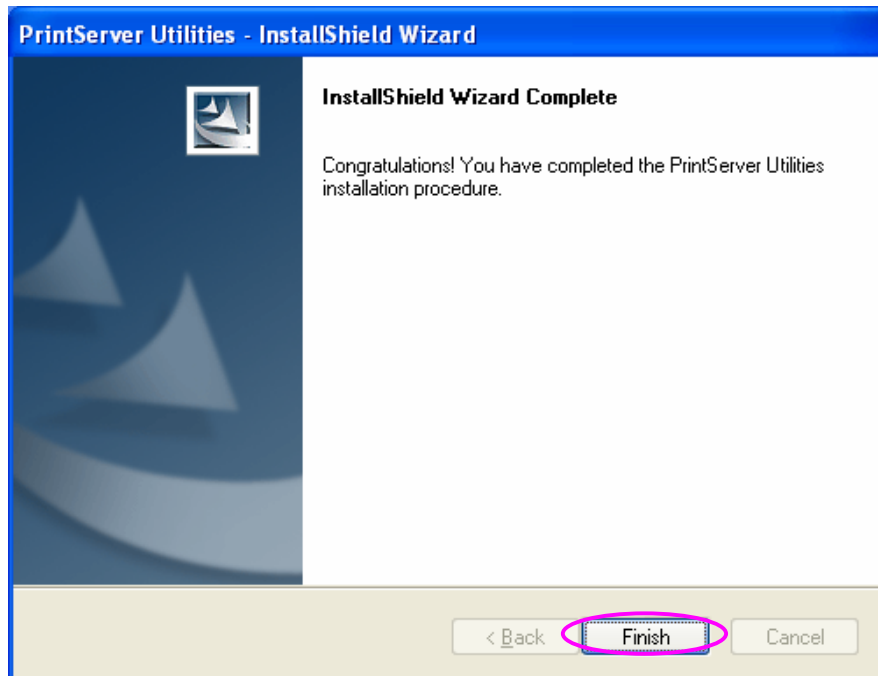

The Administrator Installation Program have executed the installation procedure that performs the following tasks:

Install all utilities and drivers to the administrator’s PC.

Configure the print server (including the print server name and network protocol)

Add the network port of the print server to the administrator’s PC.

If you want to print from this administrator’s PC to the print server, all you need to do is to perform Windows’ standard “Add Printer” procedure (please refer to Section 3.6).

3.3 Administrator Utilities

1. After Administrator Installation is completed, there will be four utilities in print server's Program folder.

Network Ports Quick Setup – Add the network ports of print servers within the network to your PC.

Print Server Configuration – Allows you to configure the print server's IP Address, network protocols and other advanced functions. Please refer to Chapter 7 for the detail instruction of the configuration.

Remote Ports – Add the network port of remote printer server to your PC.

Uninstall – Assistant for removing all installed administrator software.

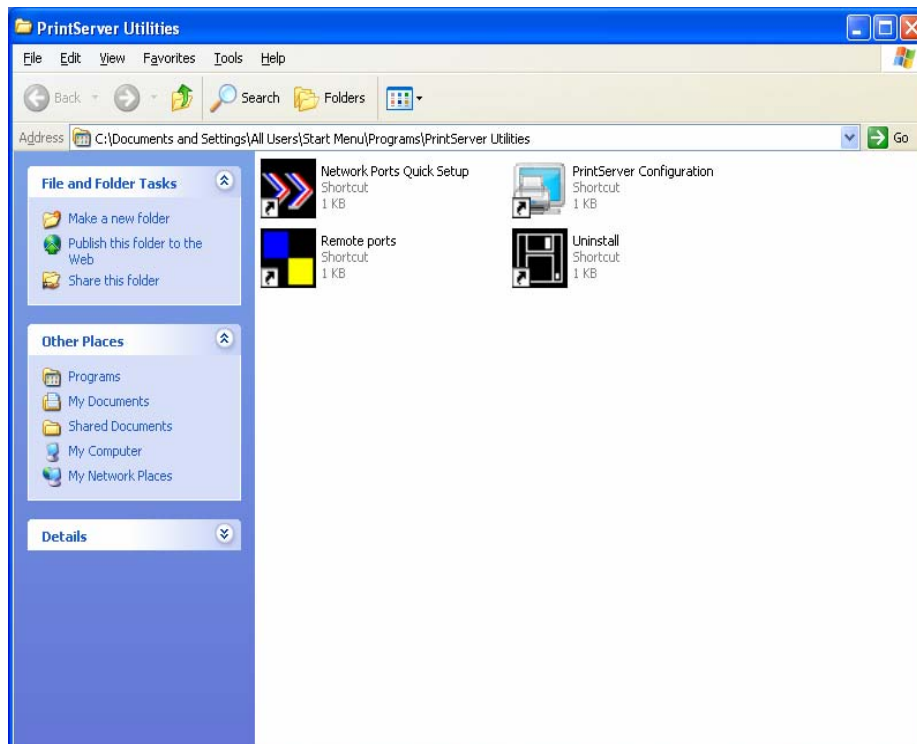

3.4 Client Installation and Setup

**Please find the utility manually from CD-ROM drive's root directory or download it from Edimax website. If you have any question please check with Edimax local technical support team.*

The Client Installation Program is a wizard driven procedure which will perform the following tasks:

- Install client utilities and drivers into your PC.
- Automatically add all Network Ports to your PC.

The network port driver supports network protocol auto-detection. It will automatically select an available network protocol (TCP/IP, IPX or NetBEUI) of the client computer to connect to the print server.

Since both the print server side and client side support multi-protocols, the configuration process of the client side is fully automatic.

After the installation, perform the standard "Add Printer" procedure and choose the print server's "Network Port" in the "Available Ports" list. You can test printing from the PC to the print server as your local printer.

The Client Installation can be performed on Windows 2000/XP/2003/Vista with the same user interface. Before installation, please confirm that your PC has already connected to the network and installed at least one network protocol. Note that the following steps are running in Windows XP, for other Operation Systems the procedures are similar.

1. Please execute the Client installation software manually.

2. The “Print Server Utilities” window will be displayed. Click “Next”.

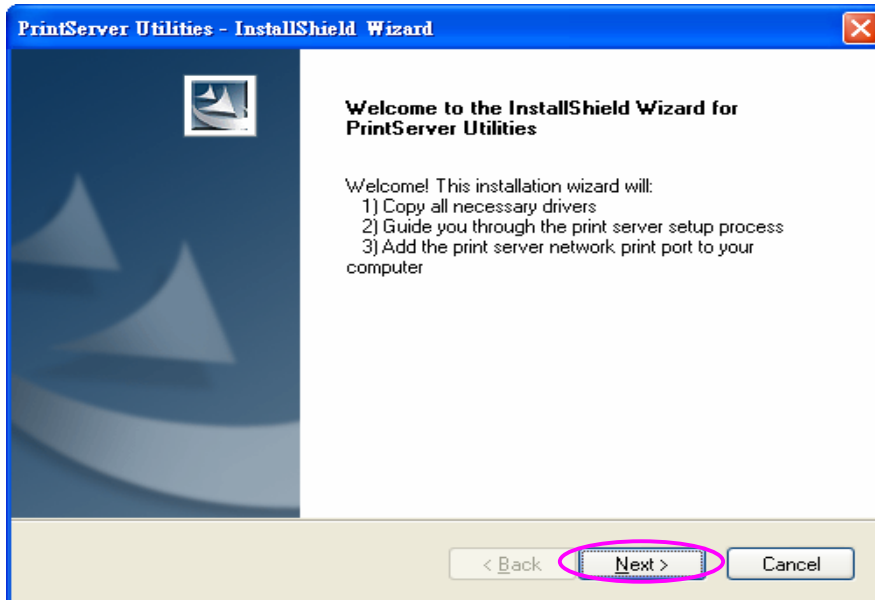

3. Click “Next” to install the utilities in the default folder or click “Change” to specify the destination folder where you would like to install the utilities.

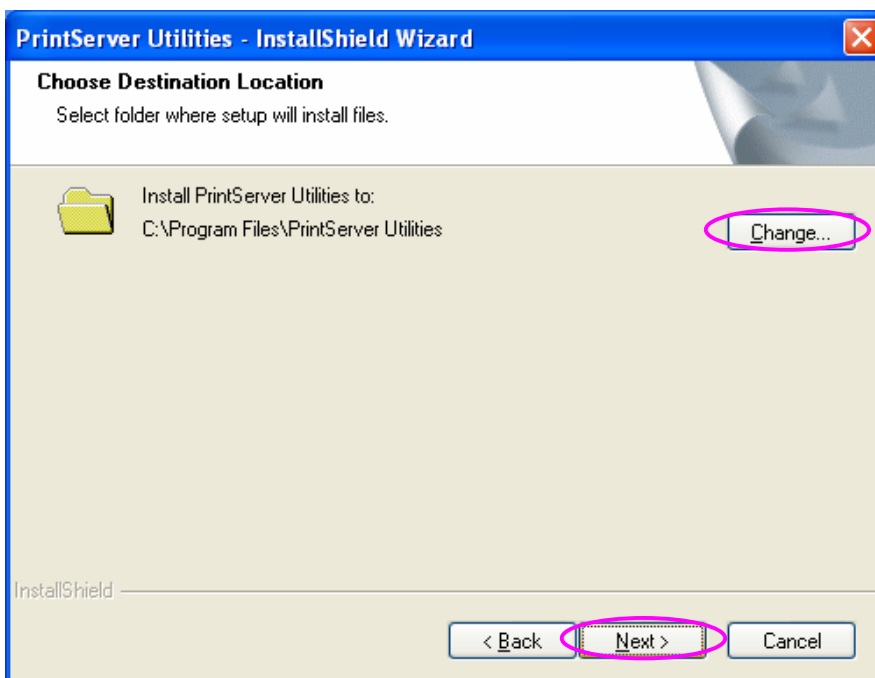

4. Click “Install”

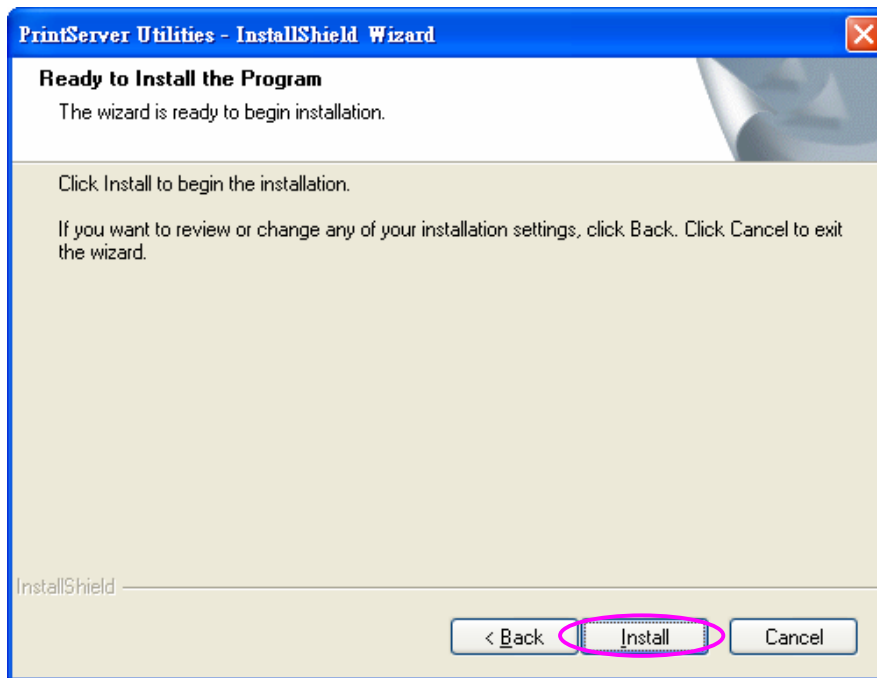

5. The system will start to install the utilities automatically.

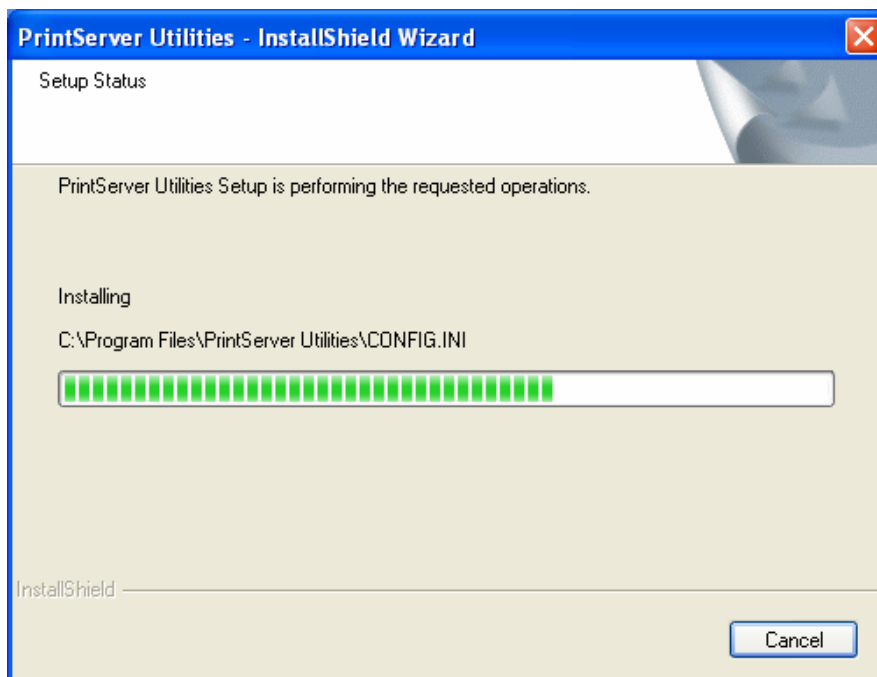

6. Now, the installation procedure is completed, you are ready to set up the client's computer. All network ports of the Print Servers detected on the network will be added to your PC automatically, click "Continue".

Note that if there are no print servers detected in the network currently, please click "Continue" to finish the installation. Please refer to Section 3.5.1 to add network ports of print servers manually.

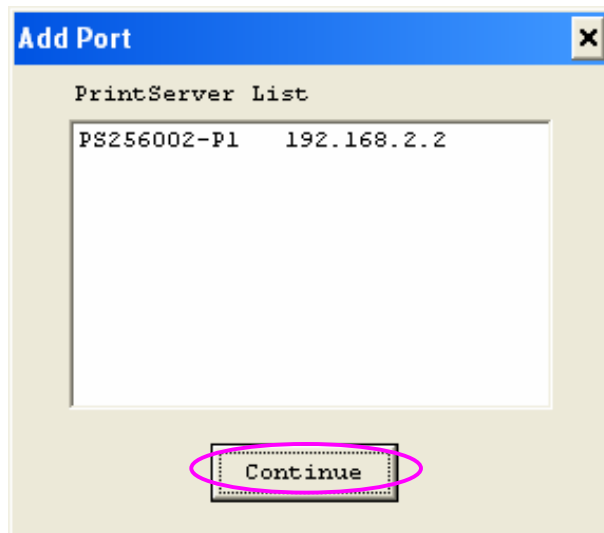

7. The Client Installation procedure is completed. Click “Finish”.

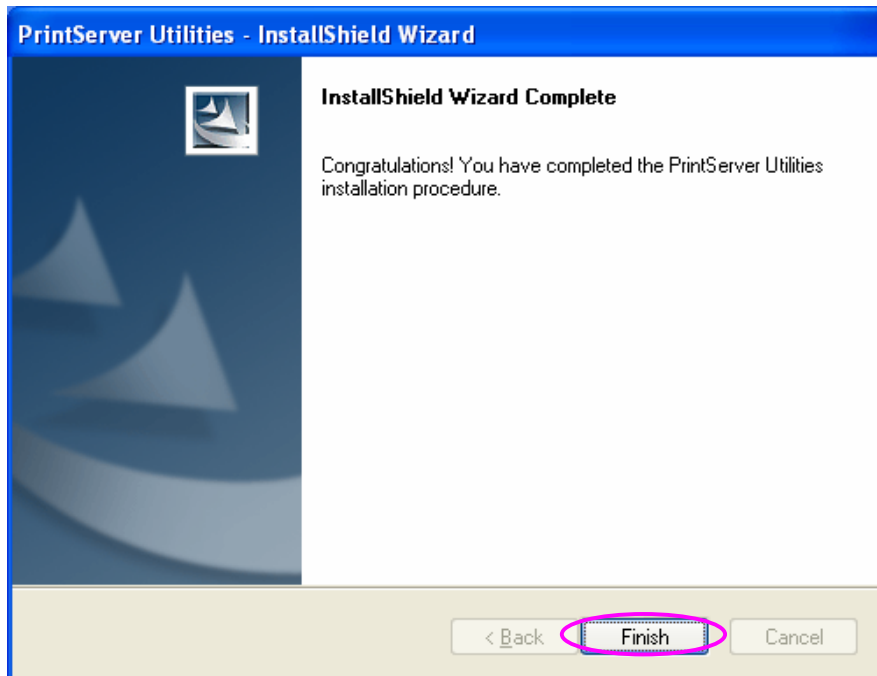

After the installation, you have completed the following tasks:

Install all utilities and drivers to the client's PC.

Add all the print server's network ports of the network to the client's PC.

You can then perform the Windows' standard "Add Printer" procedure to add network printers to your PC. Please refer to Section 3.6.

3.5 Client Utilities

1. After Client Installation is completed, there will be three tools in print server's Program folder.

Network Ports Quick Setup

Remote Ports

Uninstall Network Driver

The Uninstall Network Driver will assist you in removing all installed client software. The other two tools are described as follows.

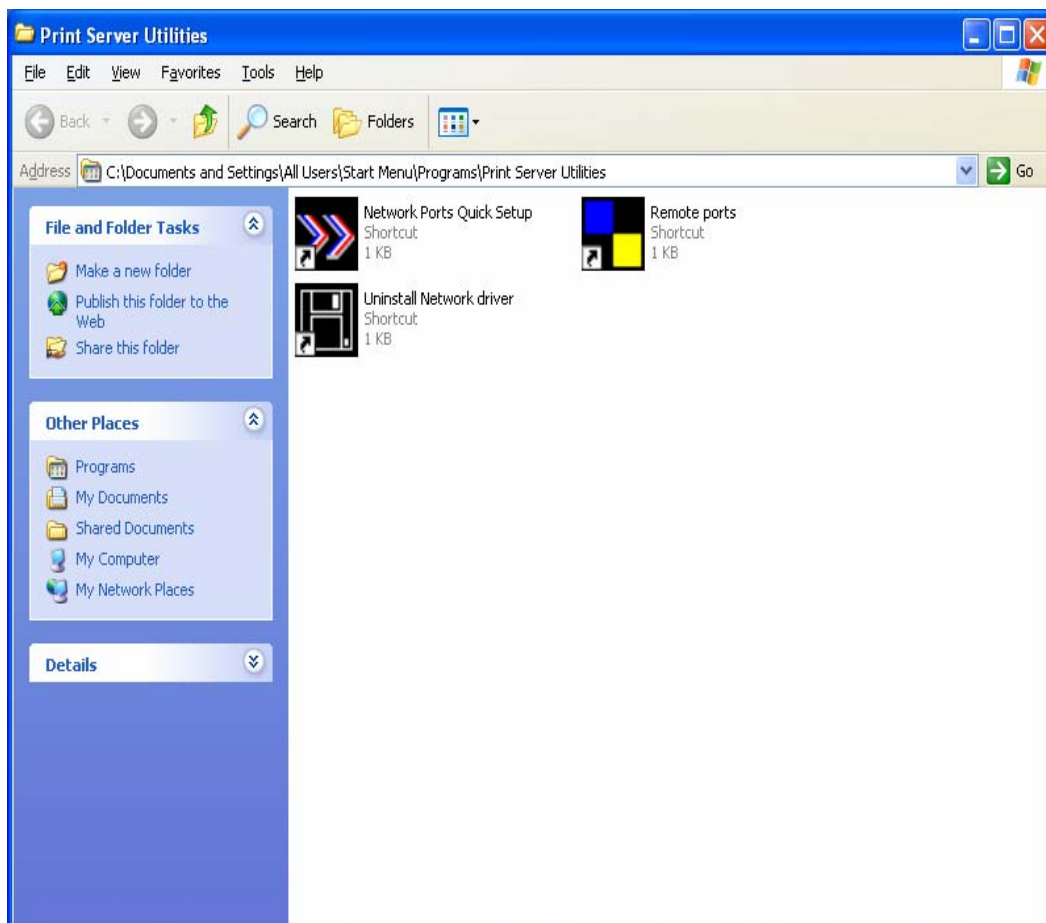

3.5.1 Network Ports Quick Setup

Network Ports Quick Setup Utility offers a very simple method to add or remove print server's printer port from the client's computer.

During the client's installation procedure, the system will automatically search for all print servers on the network, and add them into the printer ports of the client's computer (see below).

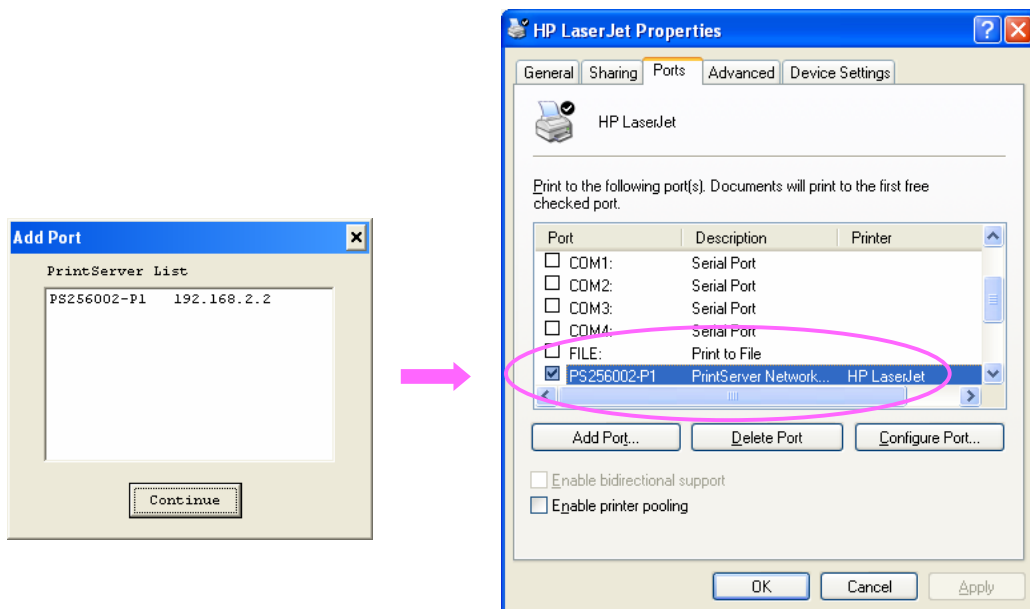

If you have just installed another new print server in the network, you must run this program first. This program will search for new print servers and allow you to add the new network printer port into client's computer conveniently. Perform the standard Add Printer procedure, then you can print directly to the printer through the newly installed print server.

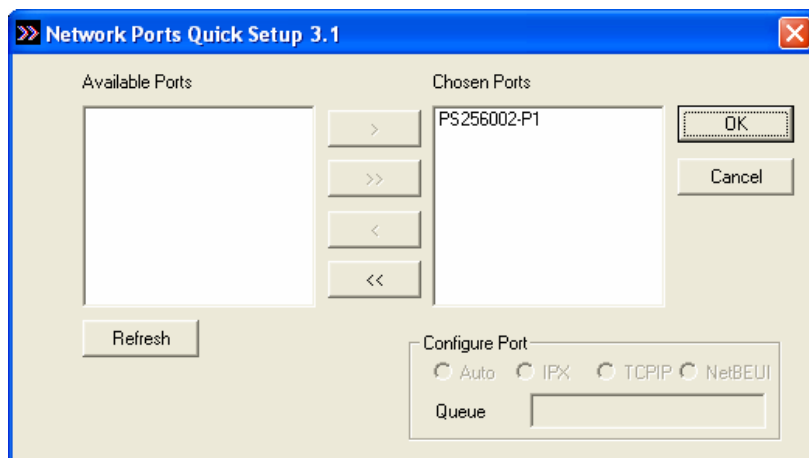

Please be aware that Network Ports Quick Setup Utility can only detect and configure all print servers on the same network, it cannot search and configure print servers on other subnets across network segments. You must use Remote Ports Utility described in the next section to manage remote (across network segments) print servers.

Select the network ports in the “Available Ports” list and click “>” to add ports. If you want to add all available ports, please click “>>”. To cancel some of the network ports or all ports from the “Chosen Ports” list, please click “<” or “<<”.

3.5.2 Remote Ports (Utility)

1. Remote Ports Utility offers a convenient way for you to manage and add printer port of the remote print server. From the assistant of this utility, you can print to other print servers outside the subnet across network segment. However, please note that this function only supports TCP/IP network protocol.
2. Please follow the procedures described below:

Step1. Run Remote Ports Utility. Clicks “Add” to add a remote print port.

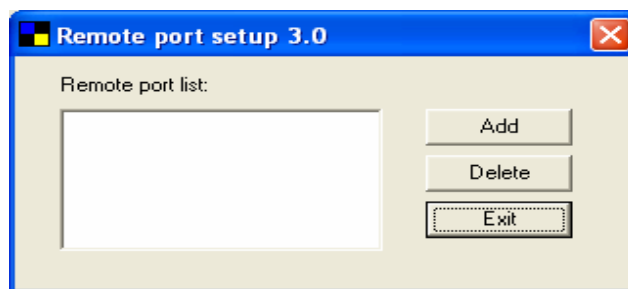

Step2. Enter print server’s name, IP address, select used ports, and enter LPR queue name of each port. Click “Ok”.

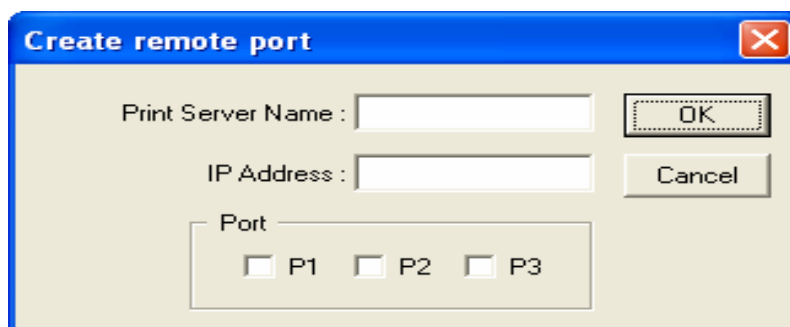

Step3. The new remote print port is displayed as follows.

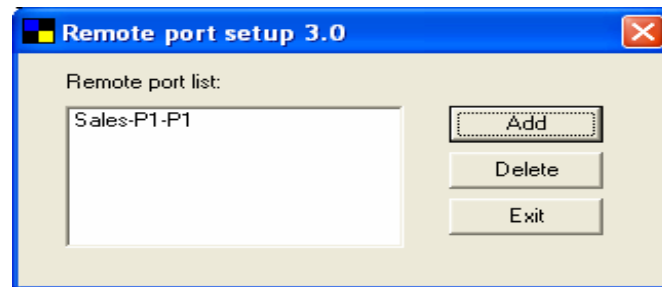

In order to use the remote printing function, you will have to proceed with normal Add Printer procedure and select your printer port as the newly added remote printer port.

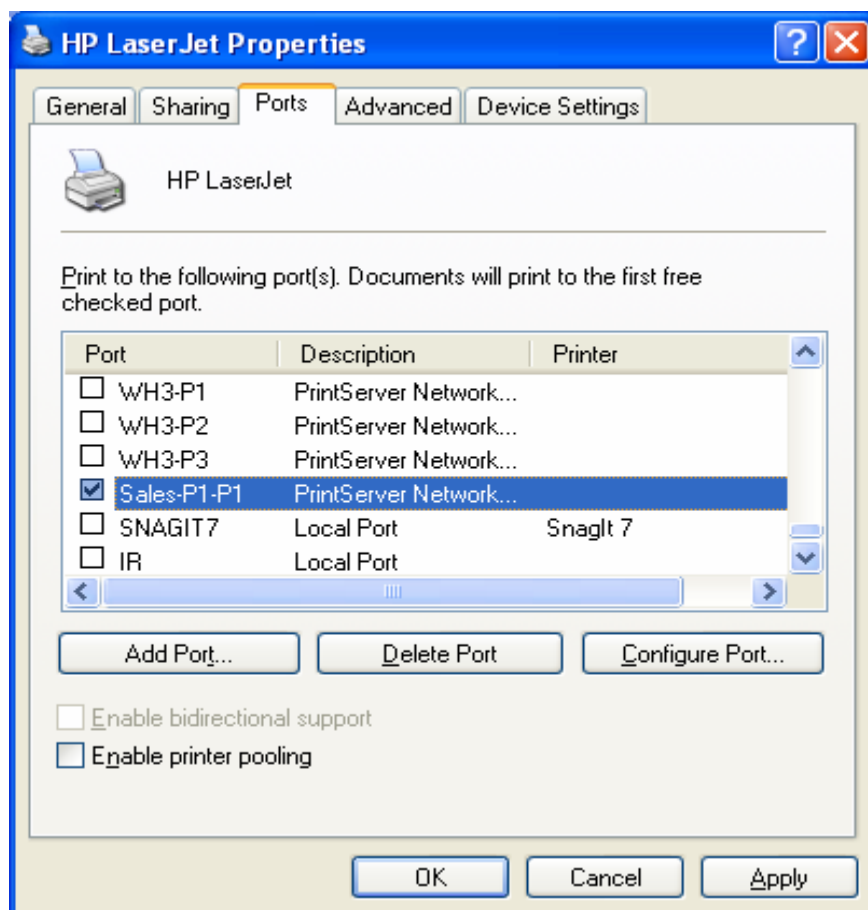

3.6 Windows Add Printer Procedure

After adding a “Network Port” of the print server to your PC by Administrator or Client Installation Program, you can follow the procedures described in the following sections to add printer to the Windows.

3.6.1 Windows Vista

1. The following “Add Printer” steps are running in Windows Vista.
2. Click “Start”, select “Settings\Printers”.
3. Click “Add a Printer”.
4. The “Add Printer” wizard is displayed. Select “Add a local printer”.

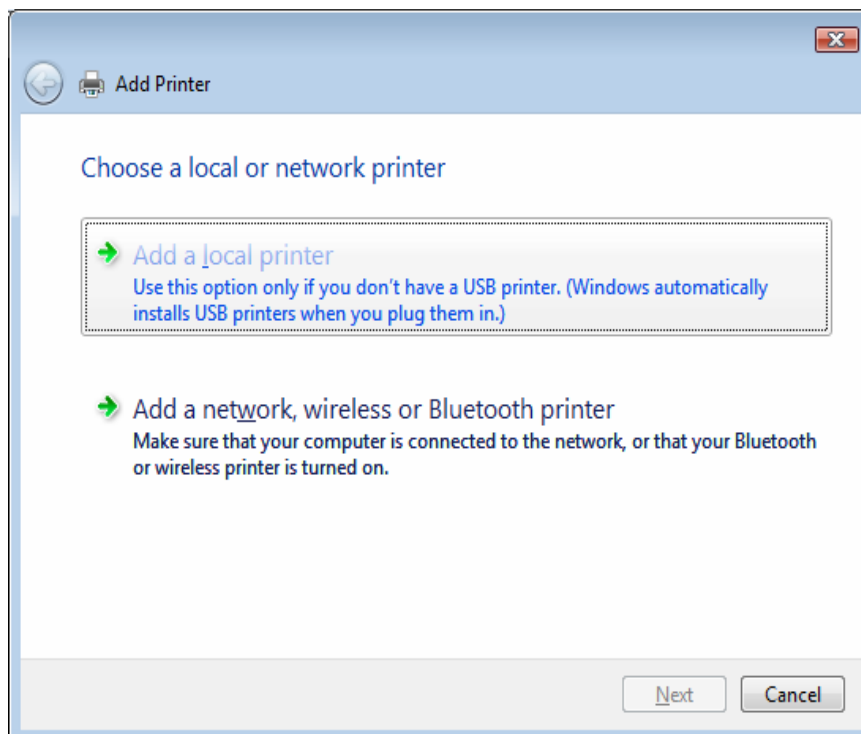

5. Choose the suitable printer port which was created by the installation process and click “Next”.

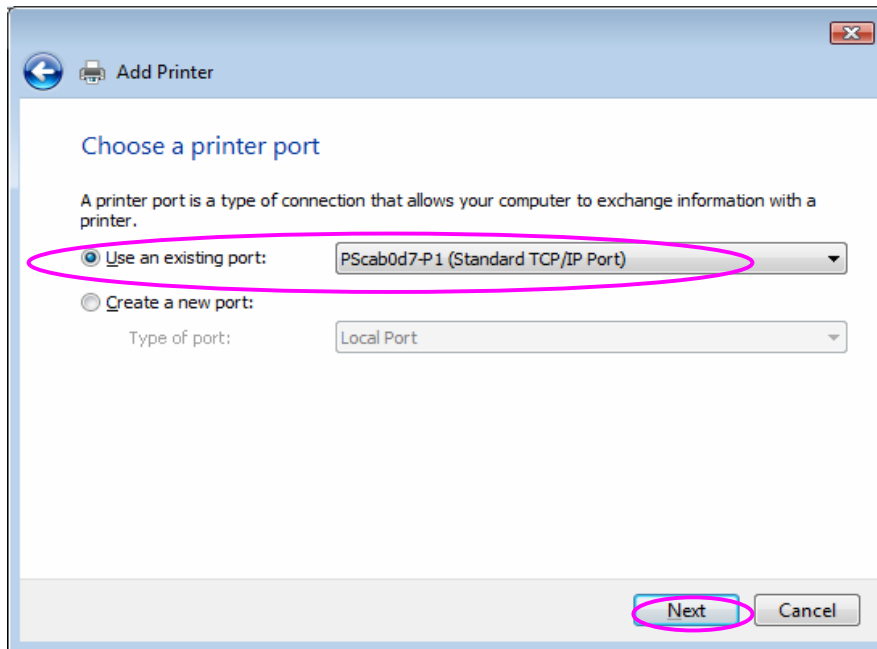

6. Select the printer manufacturer and the printer model and click “Next”. If your printer is not in the list, click “Have Disk...” to install the driver of the printer. After installation, the printer model will be added to the list.

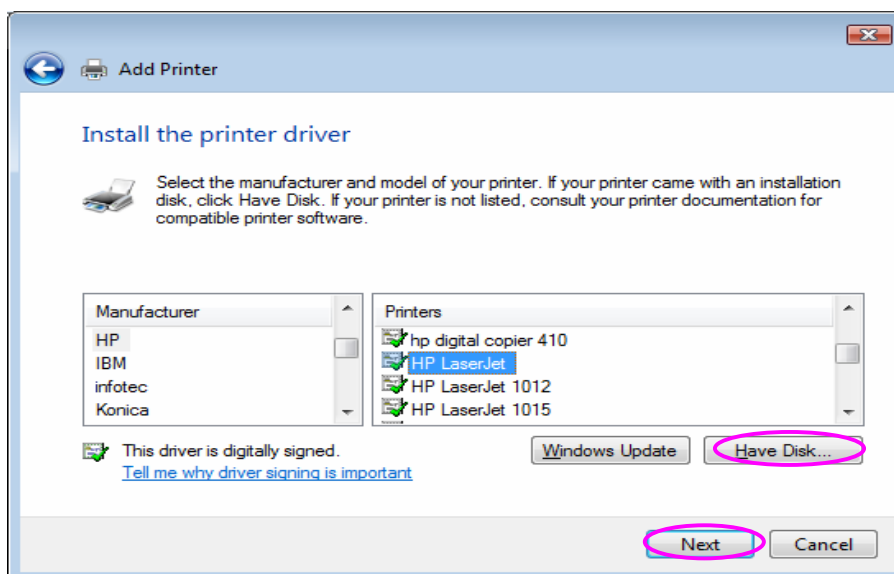

7. Name your printer and set the default printer, click “Next”.

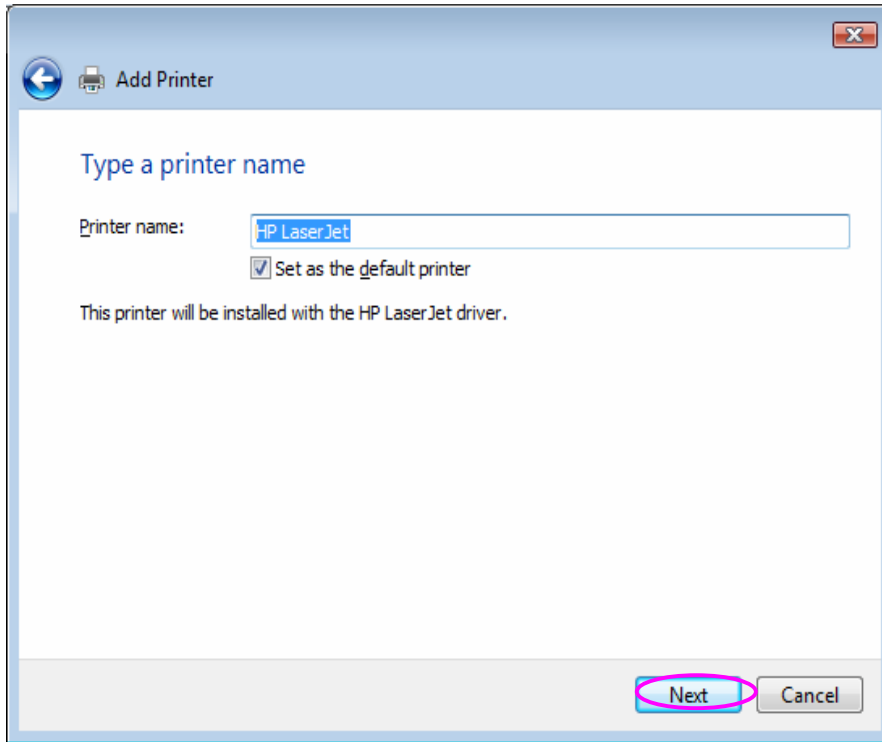

8. The printer drivers are being installed.

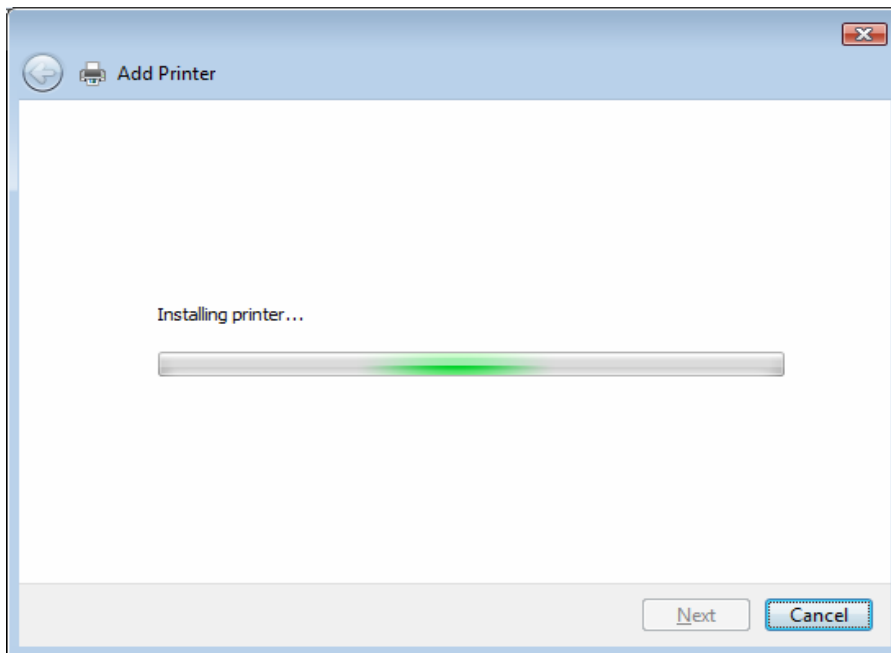

9. It is recommended to print a test page. Click “Finish”.

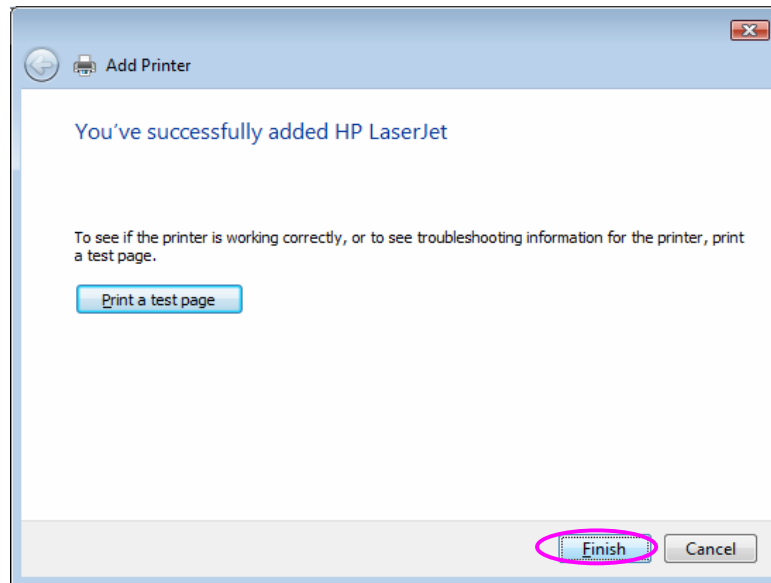

10. The printer is added to “Printers” page, you have added the printer to your computer successfully. Now you can start to print from your computer to the print server.

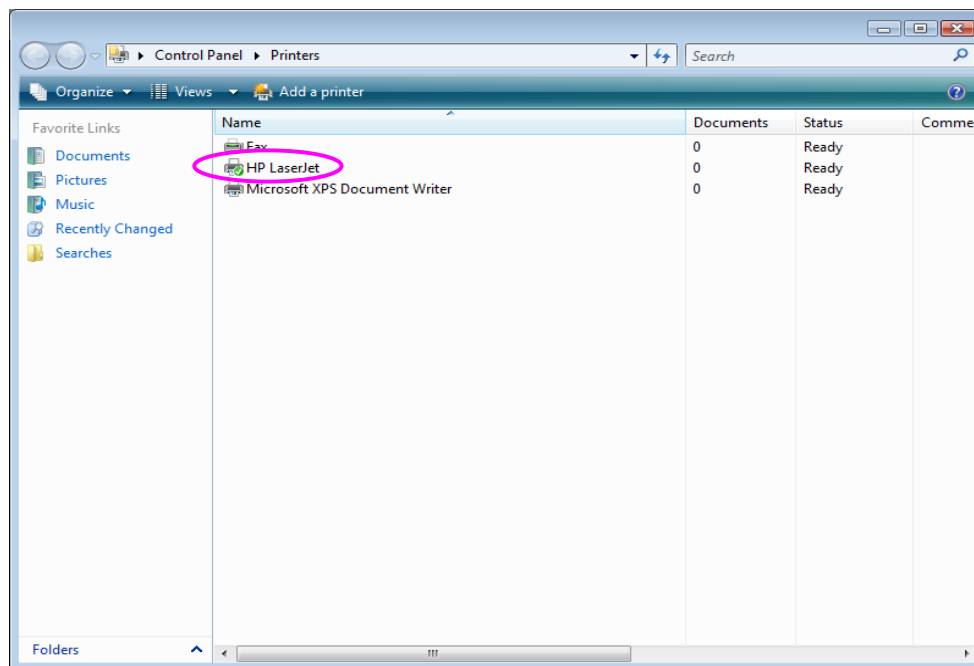

3.6.2 Windows XP

1. The following “Add Printer” steps are running in Windows XP, the steps in other Operating Systems such as Windows 98SE/Me/2000 are similar.
2. Click “Start”, choose “Settings” and select “Printers and Faxes”.
3. Click “Add a Printer”.
4. The “Add Printer Wizard” is displayed. Click “Next”.

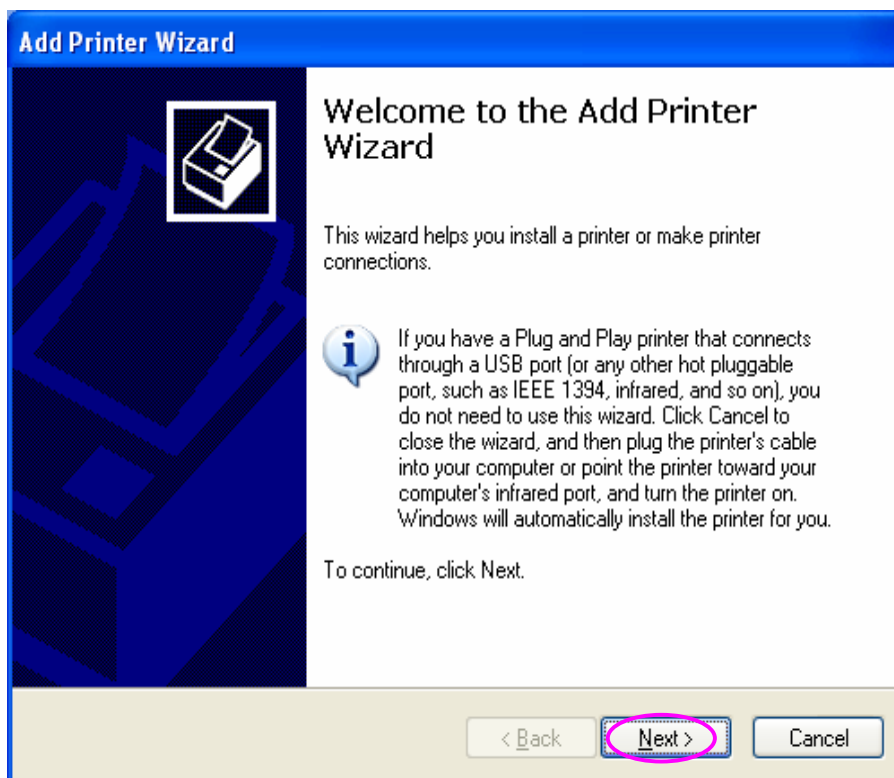

5. Select "Local printer attached to this computer" and make sure that "Automatically detect and install my Plug and Play printer" is not selected. Click "Next".

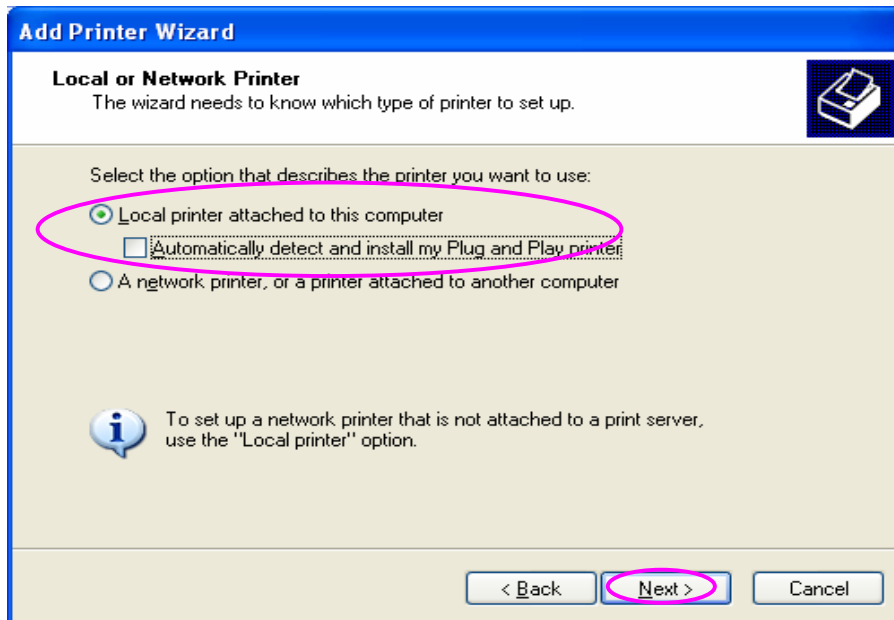

6. Choose the suitable "Print Server Network Port" which was created by the Administrator Installation or Client Installation process and click "Next".

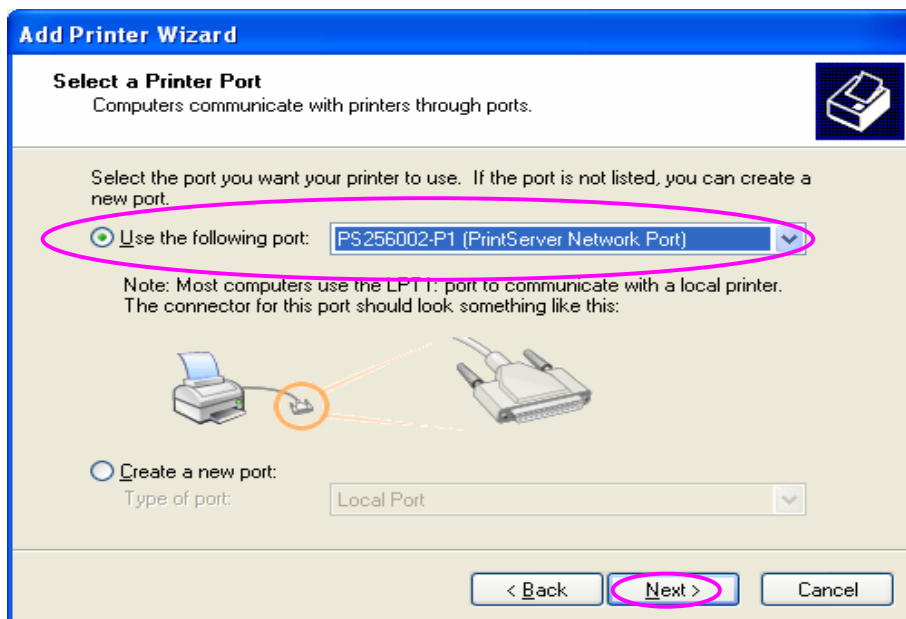

7. Select a suitable printer manufacturer and the printer model and click “Next”. If your printer is not in the list, click “Have Disk...” to install the driver of the printer. After installation, the printer model will be added to the list.

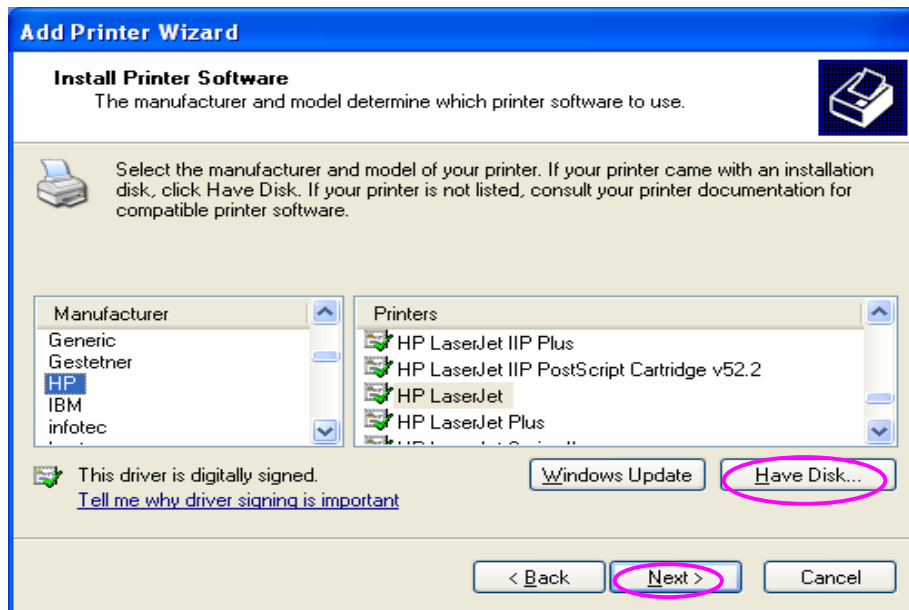

8. Name your printer and setup the default printer, click “Next”.

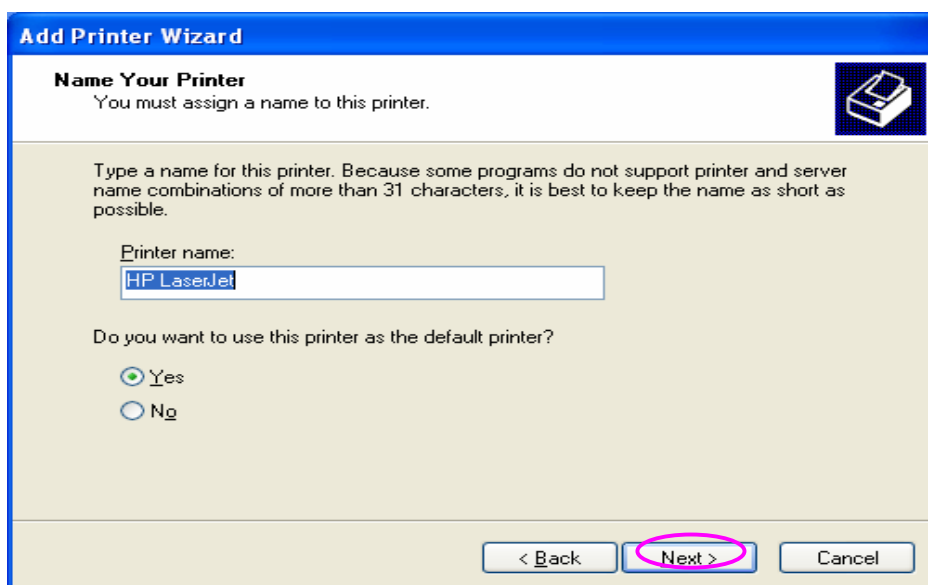

9. Choose to print the test page or not. It is recommended to print a test page. Click “Next”.

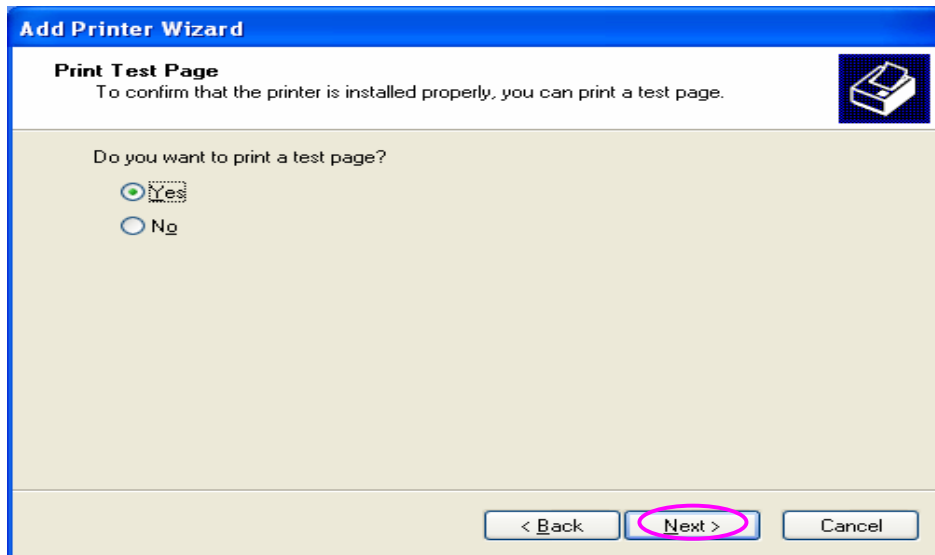

10. You have added the printer to the PC successfully. The information of the printer is displayed in the windows. Click “Finish”.

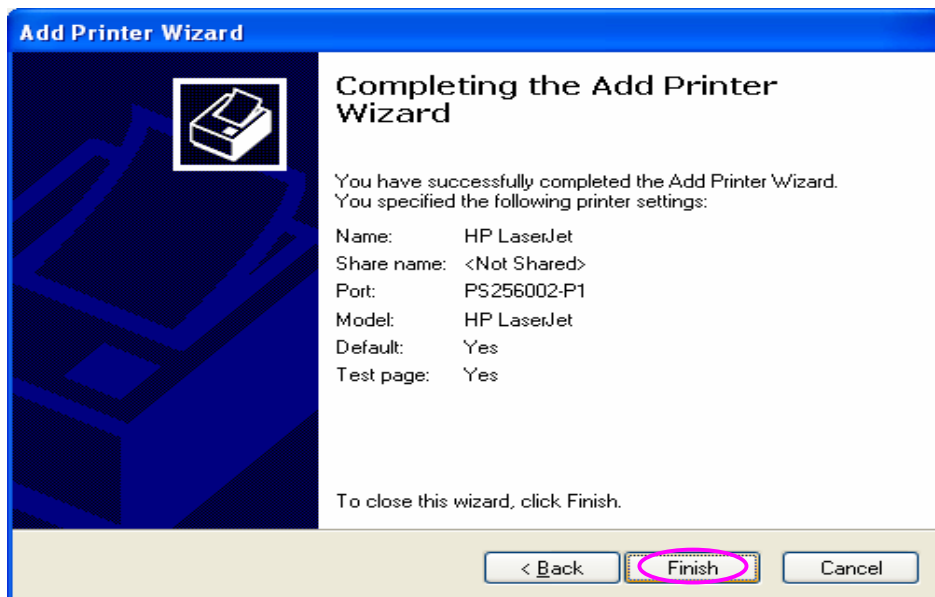

11. Now you can start to print from your PC to the print server.

4. Windows NT/2000/2003 Network

4.1 System Architecture

In Windows network environment, other than the Peer-to-Peer network printing architecture described in the previous chapter, we also offer the Server-Based Printing architecture for Windows NT/2000/2003 server. Only one Windows NT/2000/2003 is required to have Windows PTPP (Peer-to-Peer Printing) driver installed and share the printing service on the network. Other network users can simply connect to the server and access the shared printer (see below).

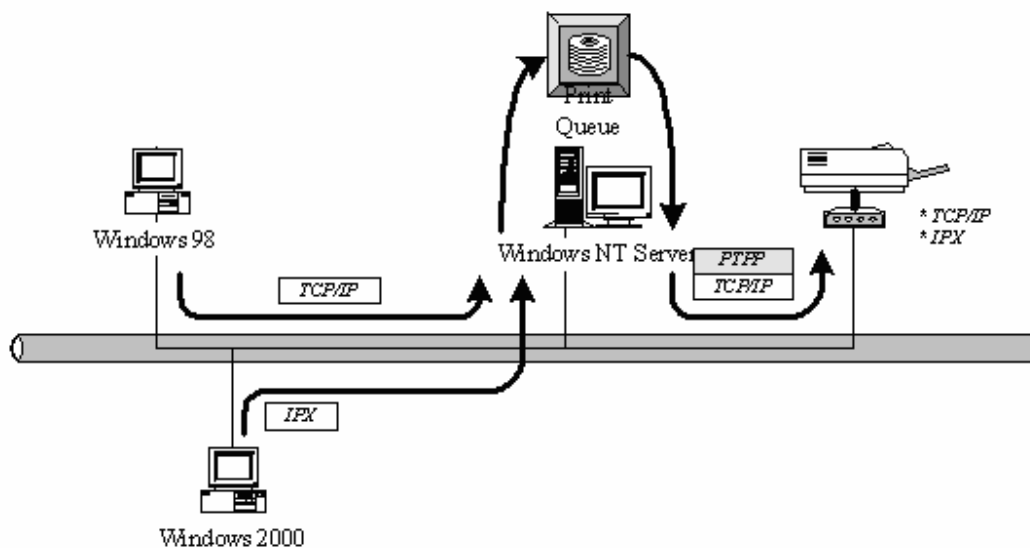

4.2 Windows NT/2000/2003 Server Installation and Setup

Please follow the procedures described below for installation and construct a peer-to-peer connection (PTPP) between Windows NT/2000/2003 Server and Print Server.

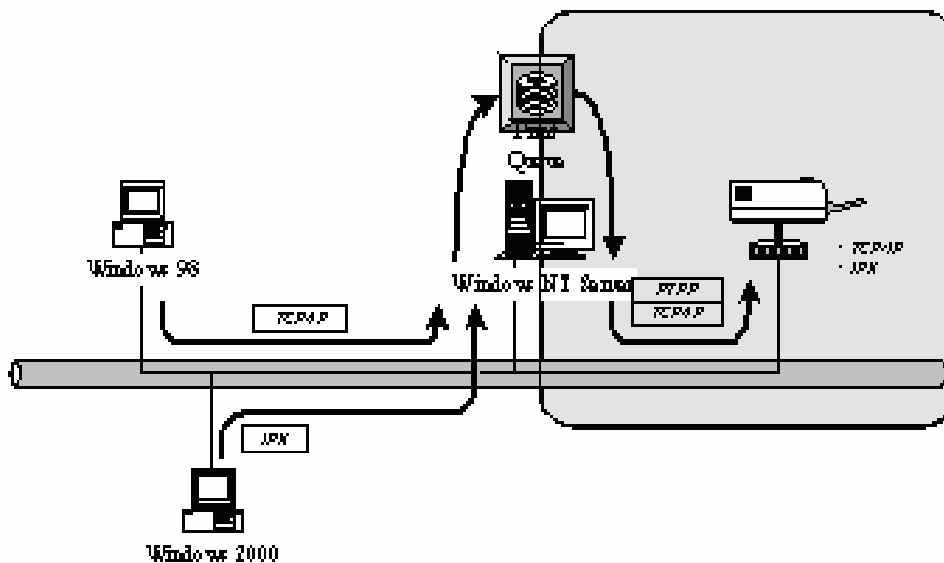

Step1.

If this is your first time installing print server, please install the administrator software on Windows NT/2000/2003 server first. Refer to section 3.2 for installation instructions.

If your network has already installed a working print server and your Windows NT/2000/2003 server has not yet installed the PTPP driver, please install the client software. Refer to section 3.4 and 3.5 for installation instructions.

Step2.

Please add/configure the Peer-to-Peer Printing of the Windows NT/2000/2003 network printer and verify that you can print from Windows NT/2000/2003 to the print server by the installed PTPP driver.

Step3.

Share the above server's printer to the network by performing the standard Windows printer sharing process.

4.3 User Installation and Setup

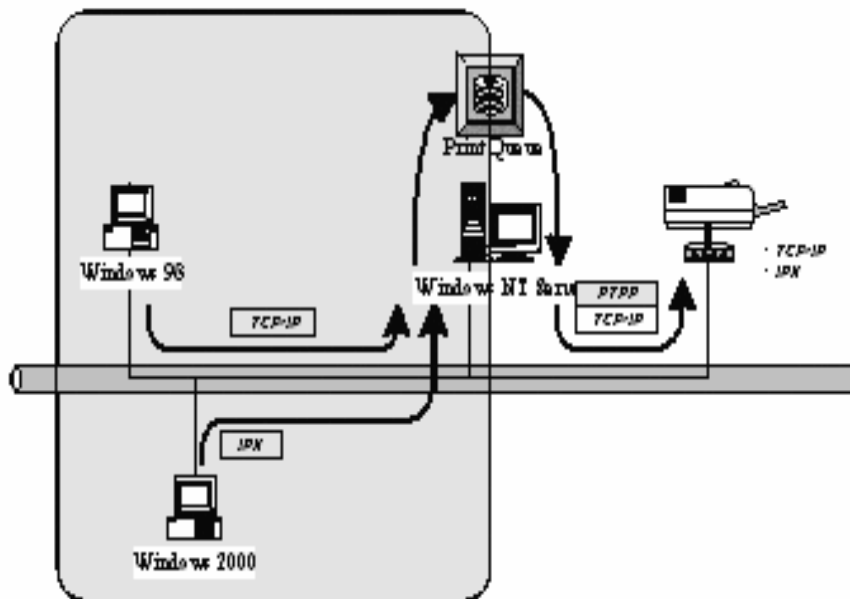

After server side's installation is completed, client side will be able to find the server's shared printer in Network Neighborhood. You only need to perform Window's standard **Add New Printer** procedure, select "**Network Printer**" shown in the screen below, and complete the configurations afterwards to access the shared printer.



5. NetWare Network

5.1 System Architecture

We implement NetWare printer sharing functionality into the print server itself, thus allowing one or more printers attached by a print server to be connected to the network. We have developed the print server to support NetWare print server.

Embedded print server, which emulates the “queue management functionality” of NetWare print server, PSERVER program running on the NetWare server. A user first prints a job at a workstation, the job is routed to a NetWare server, the NetWare server stores the job in a print queue and then the print server gets the print job from the queue to printers.

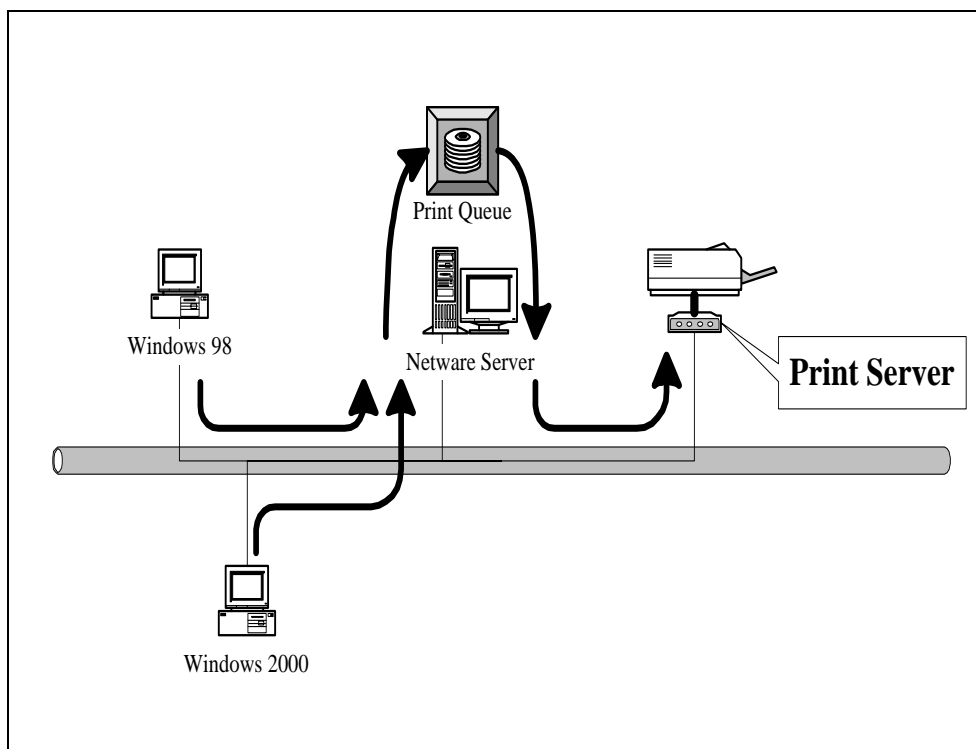

Compare with NetWare printing functionality, the advantages of embedding the NetWare network printing functionality in the print server include:

1. Installation is easier and quicker.
2. Network management is easier.
3. Printing performance is enhanced.
4. Relieve NetWare file server's burden.
5. Relieve the need of a workstation running the remote printer utility.
6. Improve productivity by locating the printer near the workgroup.
7. Each print server should log into a NetWare server before servicing the print jobs. Each print server will occupy a user account with which it can log into the NetWare server.

5.2 NetWare 3.x/4.x/5.x Installation & Setup

Once your print server is connected to your Ethernet network, you can set it up for use with your networking software.

5.2.1 Installation Using PCONSOLE

5.2.1.1 Configuring as Print Server Mode

1. Run the NetWare PCONSOLE program.
2. Change the current file server, if necessary, using the Change Current File Server menu selection.
3. Choose the Print Queue Information menu selection.
4. Press the Insert key to add a new print queue.
5. Type in a print queue name, such as “PQ” or “Q1”.

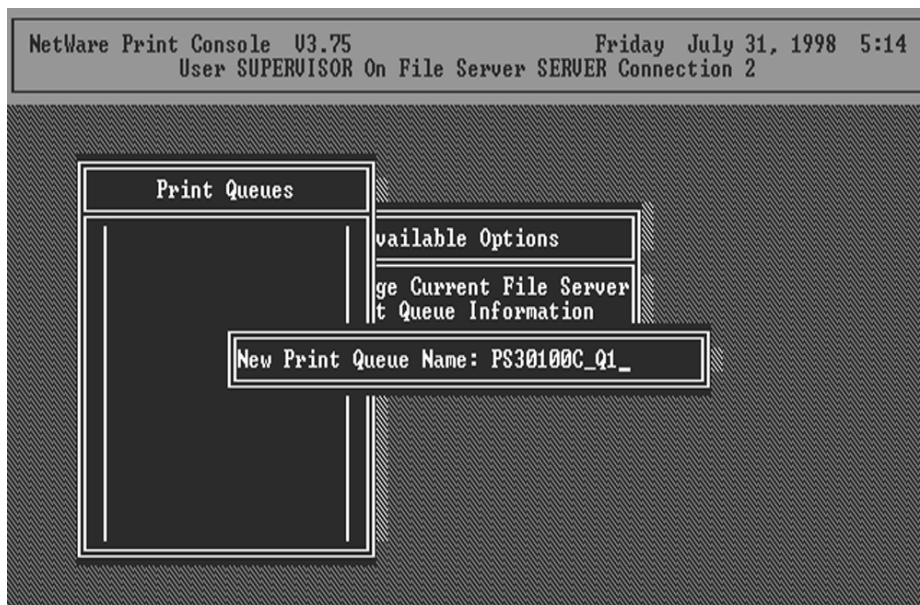

6. You have now successfully created the print queue that your print server will serve. Press the Escape key until the Available Options main menu is displayed.
7. Select Print Server Information.
8. Press the Insert key to add a new NetWare print server object. The print server name can be identical to the PSxxxxxx name printed on the label of the print server.

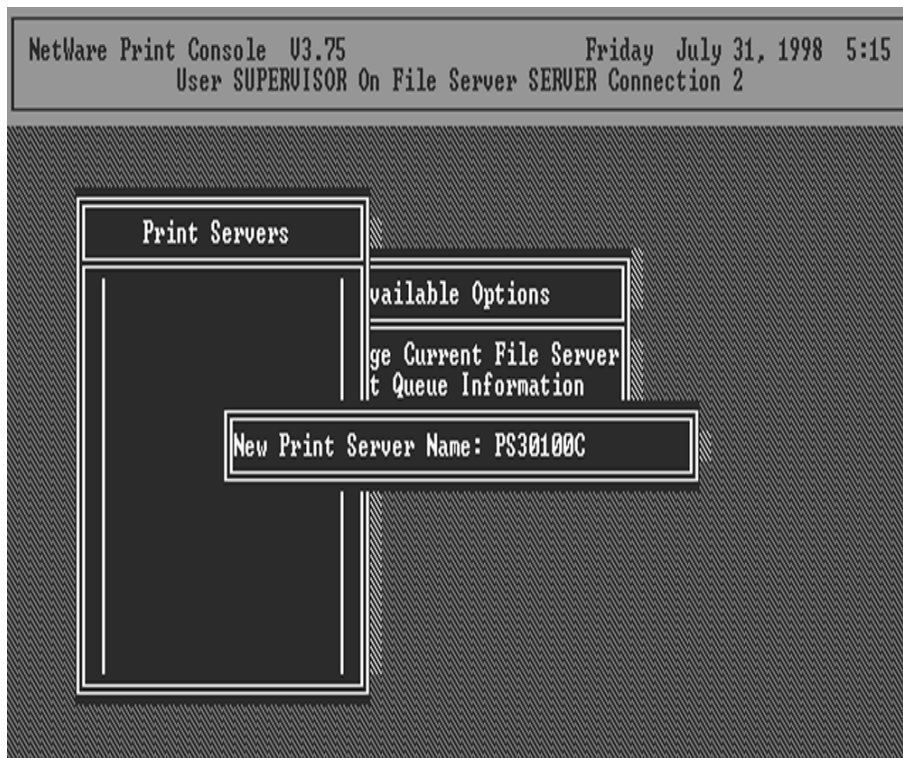

9. Press Enter to select the newly created print server.
10. Select Print Server Configuration.
11. Select Printer Configuration.

12. Select Printer 0 (or Printer 1, Printer 2), and press Enter, then select LPT1 (or LPT2, LPT3) in the Type field. If your print server is with only one port, you do not need to configure this Type field.

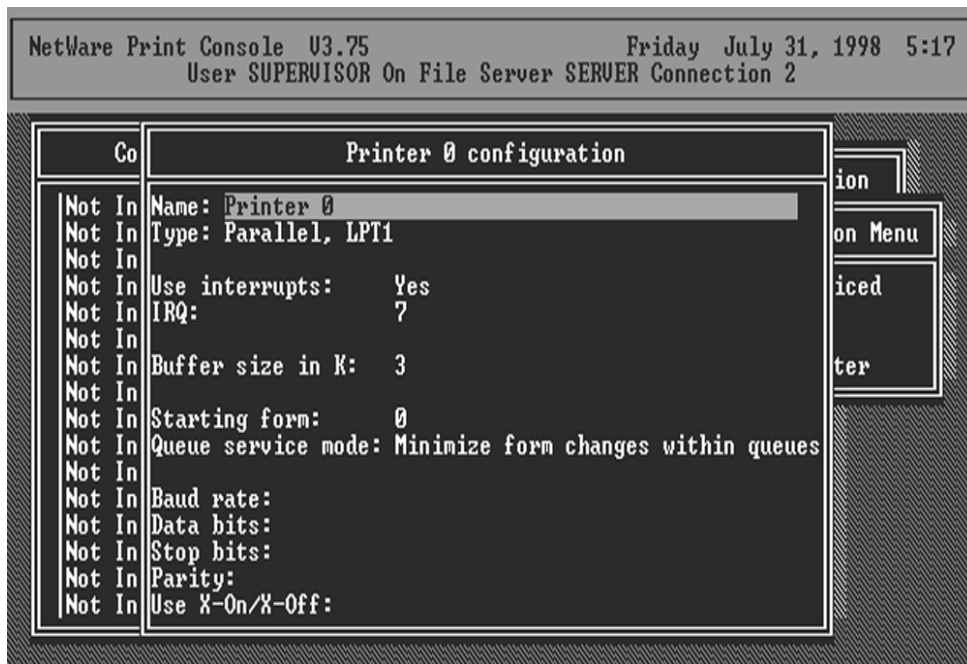

13. Press Escape, and answer Yes to the Save Changes question.
14. Select Queues Serviced by Printer, then select Printer 0 (or Printer 1, Printer 2) and press Enter.

15. Press *Insert* and add your newly created print queue to the list of queues serviced by the printer. Enter a priority number for the queue service, or press Enter to accept the default.

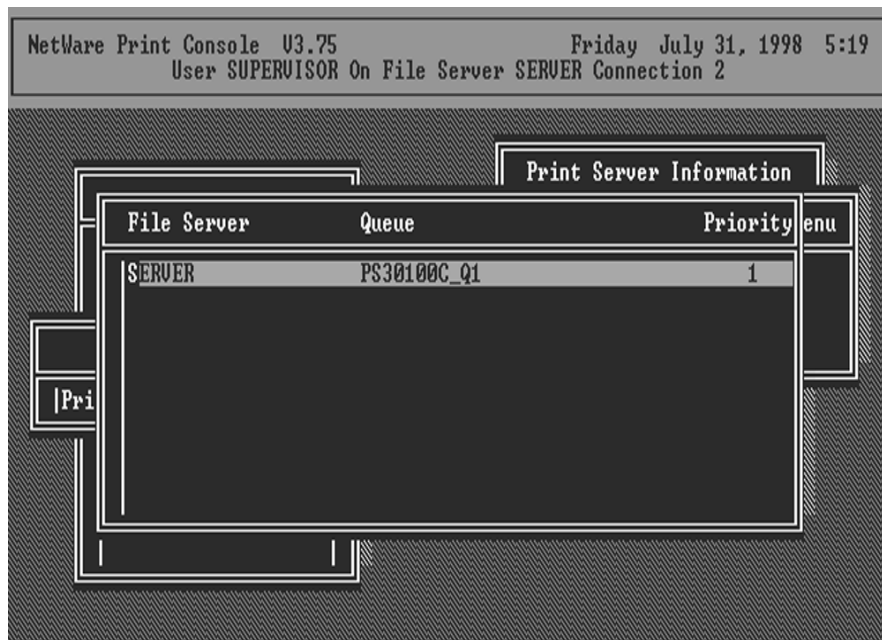

16. Repeatedly press Escape to exit the PCONSOLE program.
17. Reset the print server to have the changes take effect.

NOTE:

If the print server you have is with multiple printer connectors, you may create multiple print queues and printer objects.

Your print server should now be ready to use. You should be able to redirect printing to your print server using a CAPTURE command such as the one shown in the previous section.

6. UNIX System Network

6.1 Introduction

The print server is available for TCP/IP printing by Unix LPD (Line Printer Daemon) protocol. The LPD protocol originated with Unix release is based on the BSD version of Unix and supported under most versions of Unix.

This chapter explains how to configure the print server for TCP/IP operation, and how to modify configuration files on your Unix system to allow printing to the print server. The configuration examples in this manual follow the syntax for BSD based Unix systems. Please refer to the related system documentation for the correct syntax of your systems.

To configure the print server for LPD printing, perform the procedures below:

1. Enable Print Server's TCP/IP Support.
2. Set up Print Server's IP address.
3. Verify Print Server's IP Address.
4. Configure remote LPD printing on the host.
5. Print a test page.

In the next sections, we will describe these five procedures step by step.

6.2 Enable Print Server's TCP/IP Support

The default configuration of the print server is with TCP/IP support enabled. Anyway, you can configure the print server to enable TCP/IP support using the configuration program.

6.3 Setup Print Server's IP Address

The print server must have a unique IP address in order to be recognized by the network.

You can set up the IP address on the various Unix systems using any one of the following methods:

1. DHCP (Dynamic Host Configuration Protocol)
2. BOOTP (Bootstrap Protocol)

The print server will use the last three methods to obtain its IP address automatically if its IP address is configured as Auto (0.0.0.0).

6.3.1 DHCP

There are many Unix systems that support DHCP protocol, and the procedures to configure the DHCP server database are different. This manual does not describe the DHCP server configuration on the Unix systems. It is highly recommended that the DHCP server should be located on the same network as the print server.

6.3.2 BOOTP

If you have the BOOTP daemon, `bootpd`, running on your UNIX system that is accessible by the print server, you can use the BOOTP protocol to set up the IP address of the print server. We recommend that the BOOTP server should be located on the same subnet as the print server. If you use Network Information Services (NIS) in your system, you may need to rebuild the NIS map with the BOOTP services before doing the following BOOTP configuration. To rebuild the NIS map, please refer to your system documentation.

To configure the IP address data for the BOOTP server, you will need to log in the host of BOOTP server as the superuser (root). Perform the following steps to add address entries,

1. Optionally, assign a name corresponding to the print server's IP address. You can add this address to the `/etc/hosts` file, by adding a line such as:

```
203.66.191.12          pserver
```

2. Add an entry to the host's `/etc/bootptab` file, similar to the following:

```
hostname:\
```

```
:ht=1:\
```

```
:ha=print_server_ethernet_address:\
```

```
:ip=print_server_ip_address:
```

Lines should be indented with tabs.

Where hostname is the device name of a print server, the ht=1 tag specifies the hardware type is Ethernet, the ha= tag specifies the Ethernet address of a print server, which is the Node ID located on the print server. The ha tag must be preceded by the ht tag. The ip= tag should correspond to the IP address you want to assign to the print server.

For example, a print server with the following configuration:

**Node ID: 0000B4010101 (this implies Ethernet
address is 0000B4010101),**

IP address: 203.66.191.12

The entry for this print server in the /etc/bootptab file should be:

PS010101:

:ht=1:

:ha=0000B4010101:

:ip=203.66.191.12:

6.4 Verify Print Server's IP Address

To verify that your print server is responding to the newly assigned IP address using a PING command:

```
ping ip-address
```

6.5 Configure Remote LPD Printing on the Host

The procedure you use to configure your Unix host(s) to allow printing to your network remote print server varies between different varieties of Unix. The procedure below can be used for Unix variants that are related to BSD Unix, such as SunOS or Linux. For other versions of Unix, consult your system documentation, keeping in mind that:

1. The print server should be treated as a BSD networked print server host.
2. The host name should be the name (or IP address) that you have assigned to the print server.
3. The printer name (or queue name) on the remote host should be lpt1, lpt2 or lpt3, the name of the printer port on the print server.

You will need to perform the tasks below, logged in as the superuser (root). To configure your Unix host for printing,

1. Optionally, assign a name corresponding to the print server's IP address. You can add this address to the `/etc/hosts` file, by adding a line such as:

```
203.66.191.186      pserver
```

2. Create a spool directory for the printer in the same directory where spool directories are normally kept on the machine, such as `/var/spool` or `/var/spool/lpd`:

```
mkdir /var/spool/lpd/pserverd
```

```
chown daemon /var/spool/lpd/pserverd
```

```
chgrp daemon /var/spool/lpd/pserverd
```

```
chmod 775 /var/spool/lpd/pserverd
```

3. Add an entry to the host's `/etc/printcap` file, similar to the following:

```
printer-name:\
```

```
:lp=\
```

```
:rm=203.66.191.186:\
```

```
:rp=lpt1:\
```

```
:lf=/var/spool/lpd/pserverd.log:\
```

```
:sd=/var/spool/lpd/pserverd:\
```

```
:mx#0:
```

Lines should be indented with tabs. More than one printer name can be used, with variants separated by vertical bars (name1|name2).

The `rm=` entry should correspond to the IP address you have assigned to the print server. You can also use a host name if you have assigned one in the `/etc/hosts` file.

The `sd=` entry should correspond to the spool directory you created in the previous step.

The `rp=` entry should correspond to the port name of the remote printer. The values should be one of `lpt1`, `lpt2` or `lpt3` depends on the printer port.

The print server should now be available for printing from your Unix host.

7. Configuration Utility

7.1 Introduction

This chapter introduces print server's system configuration utility in Windows environment. This utility is automatically installed during Windows Administrator Utility installation procedure - refer to section 3.2 and 3.3.

This utility provides the most complete management and configuration functions on the print server side. This utility only provides configuration functions for print server itself; it does not include configuration functions for client side or other file server or NetWare server in the network environment.

The Configuration Utility provides the following configuration and management functions:

Search Print Server: Search All Available Printer Servers on the Network.

Print Server Status: Display Print Server Network Status.

General Configuration: General Information of print server.

TCP/IP Configuration: IP Address and DHCP Server Configuration.

NetWare Configuration: NetWare Printing Configuration.

AppleTalk Configuration: AppleTalk Protocol Setting.

SNMP Configuration: SNMP Information Configuration.

SMB: Configure the SMB Group Name.

System Configuration: Print Server Network Ability Setting and Firmware Upgrade.

Wireless Configuration: Wireless LAN Configuration.

Setup Wizard: Guide You Through All the Settings.

Report: List the Status of All Available Print Servers on the Network.

We will explain each function separately in the following section.

7.2 Search for All Available Print Server

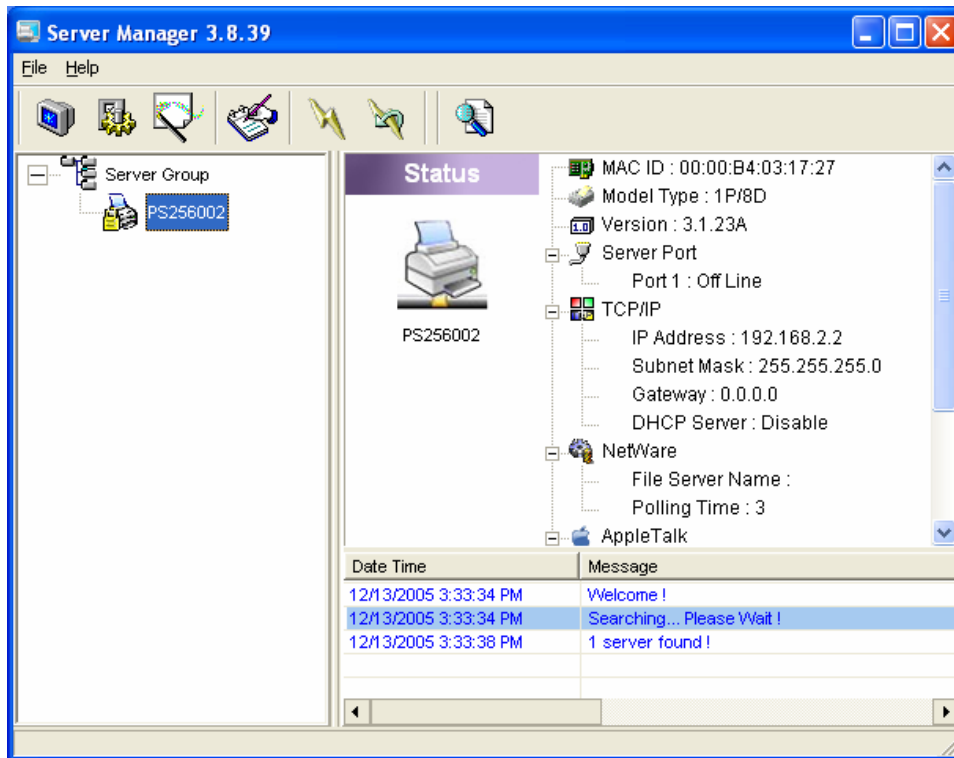

Every time when you run print server's configuration utility, click the "Search" icon  on the tool bar. The configuration utility will delay for several seconds because the utility is using system's available network protocols to search for all print servers on the network. All available print servers will be listed under "Server Group" on the left side of the window.

You must select the print server you would like to configure from the list. The system will, at the same time, display the selected print server's status on the right side of the window.

7.3 Status of Print Server

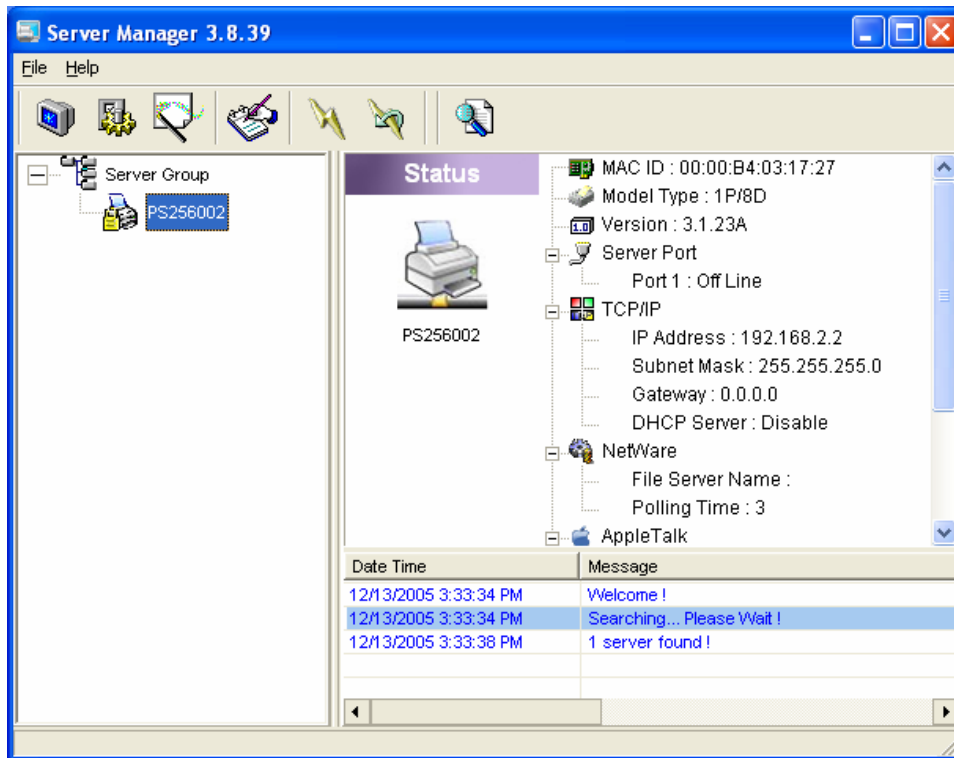

Click “Status” icon  on the tool bar, the status of the current selected print server will be showed on the right side of the window.

The information of the print server displayed are MAC ID, Model Type, Firmware Version, status of each printer port, NetWare file server name, NetWare file server polling interval, NetWare printer queue names, IP address, subnet mask, default gateway, AppleTalk printer type, AppleTalk zone and print server printing ability...etc.

You can refresh the print server’s status by pressing the “Refresh” button .

You can restart the print server by pressing the “Reboot” button .

7.4 Setup the Print Server

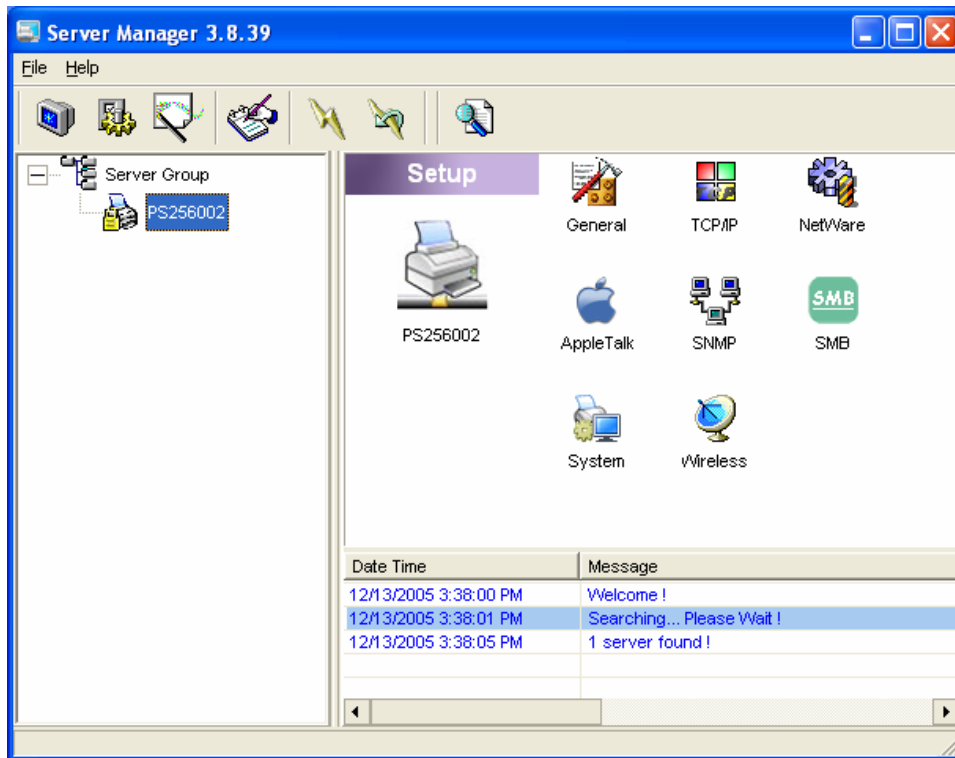

Click “Setup” icon  on the tool bar, the setup items of the current selected print server will be showed on the right side of the window.

Double click one of the icons to set up the selected print server. A screen will pop up to verify “User Name” and “Password” of the print server. The default values are as follows.

- User Name: admin
- Password: 1234

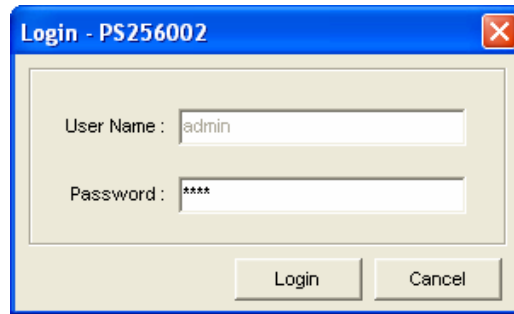

7.5 General Configuration

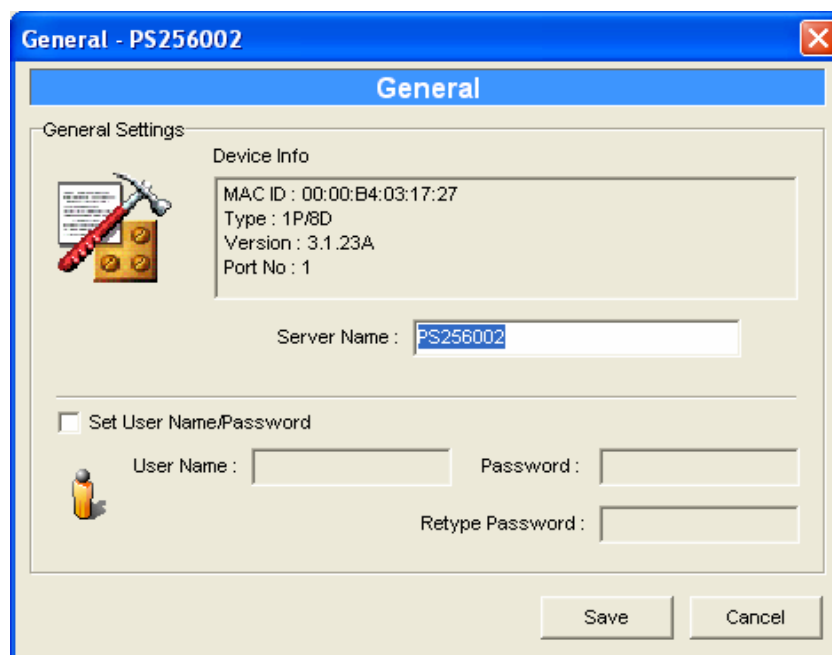

Double Click “General” icon and the General configuration window will pop-up.

You can see basic print server information in this page. You also can configure the “Server Name”, “User Name” and “Password” here.

Server Name, the name of the print server. You can use this name to identify the print server when you are searching for the print server by the administration and client utilities.

User Name / Password is used to authenticate the administrator by the Web administration tool.

7.6 TCP/IP Configuration

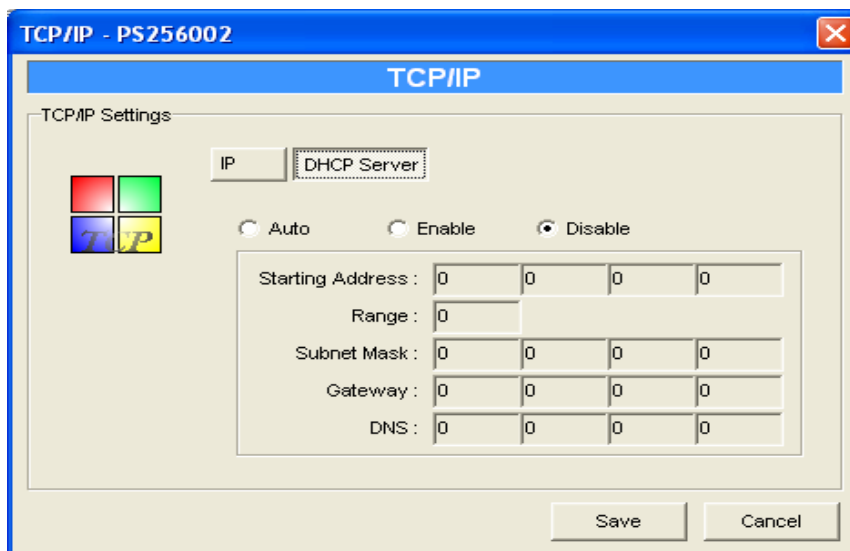
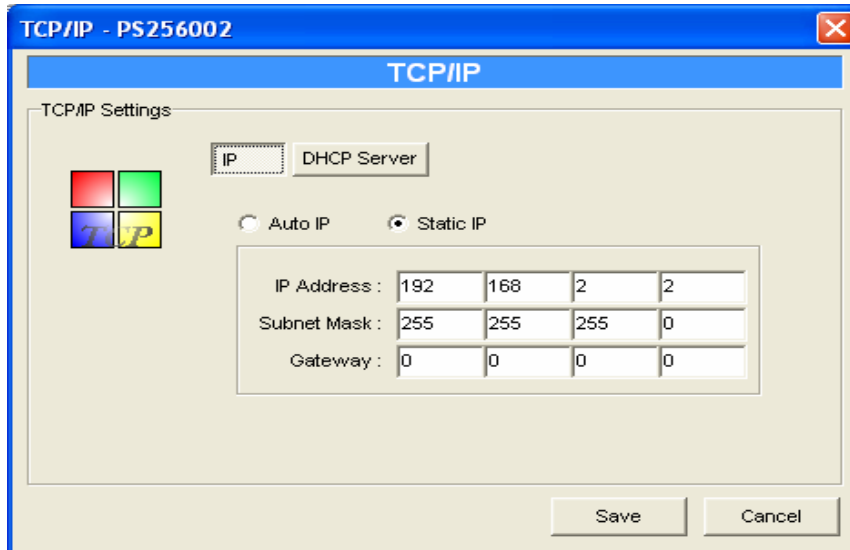

Double Click “TCP/IP” icon and the TCP/IP configuration window will pop-up.

You can configure the print server to automatically get IP from DHCP server or manually specify static IP. The print server also has a built-in DHCP server. You can enable this DHCP server and let it manages IP for you.

Click the “IP” button to enter the IP setting page. If you need the print server to automatically get an IP from DHCP server, select “Auto IP”. You also can select “Static IP” to manually assign “IP Address”, “Subnet Mask” and “Gateway” for the print server.

Click the “DHCP Server” button to enter the DHCP server’s setting page. You can “Enable/Disable” the DHCP server or set “Auto” and assign a range of IP addresses here. The DHCP server is disabled by default. If Auto is selected, the DHCP Server of print server will be enabled only when there is no other DHCP Server within the network. When “Enable” or “Auto” is selected, you have to configure “Starting Address”, “Range”, “Subnet Mask”, “Gateway” and “DNS”. The print server will assign a unique IP for each client.

7.7 NetWare Print Server Configuration

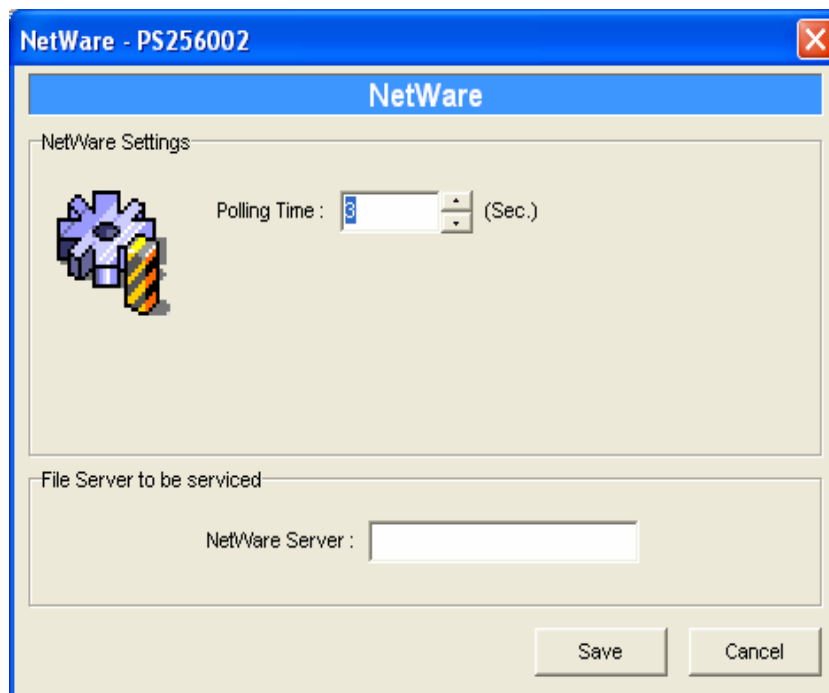

Double Click “NetWare” icon and the NetWare configuration window will pop-up.

This print server supports NetWare Bindery Printing method. The print server periodically polls the NetWare server printer queues for printing jobs. You have to assign the NetWare server name, print server polling interval and the name of queue on the NetWare server for each printer port.

Polling Time is the polling interval of the print server for waiting printing jobs on the NetWare server.

NetWare Server is the name of the NetWare file server that provides printer queues.

7.8 AppleTalk Configuration



Double Click “AppleTalk” icon and the AppleTalk configuration window will pop-up.

AppleTalk is a data communication protocol often used by Macintoshes. The print server can use these parameters to join the AppleTalk network and share the printer to other AppleTalk workstations. You have to setup the “Zone Name” and “Printer Type” for each printer port of this print server.

Zone Name: Print server has to join zones of AppleTalk before it can be shared to other workstations. Only workstations in the same zone can share the printer. If you want to share the printer to all workstations in all Zones, you should enter only “*” in the “Zone Name” field.

Printer Type, the type of printer attached to each printer port. You can get the printer type from the manufacturer of the printer.

7.9 SNMP Configuration

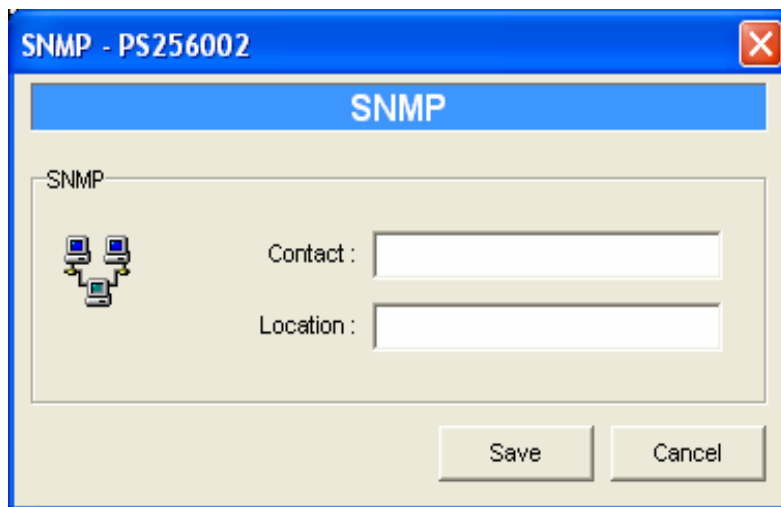

Double Click “SNMP” icon and the SNMP configuration window will pop up.

Contact: You can enter the print server administrator’s contact information here. This information will be displayed in the SNMP management tool.

Location: You can enter the installed location of the print server here. This information will be displayed in the SNMP management tool.

7.10 SMB Configuration

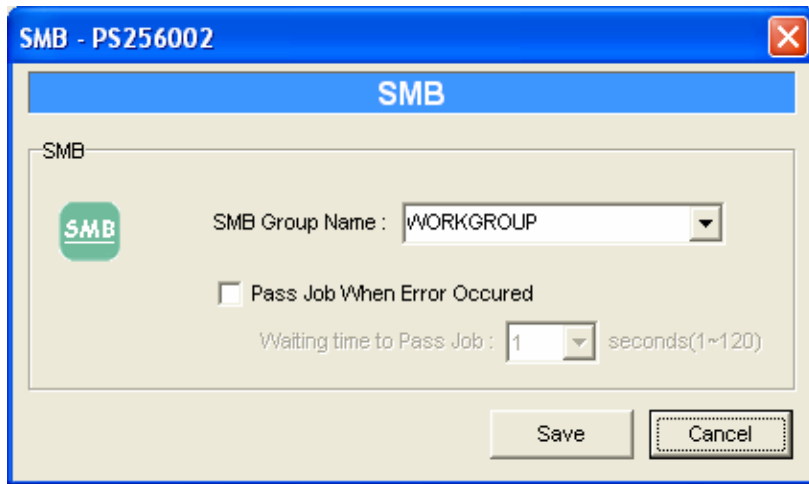

SMB Group Name, the name of SMB group that this print server belongs to. All PC should join the same group before they can use this print server by SMB protocol.

Pass Job when Error Occurred: When the printer is interrupted because of paper out or off line while printing, user can set the interval time to bypass the current printing job. Or the printing document will not be printed completely or with unformatted messages. The range is from 1 to 120 seconds.

7.11 System Configuration

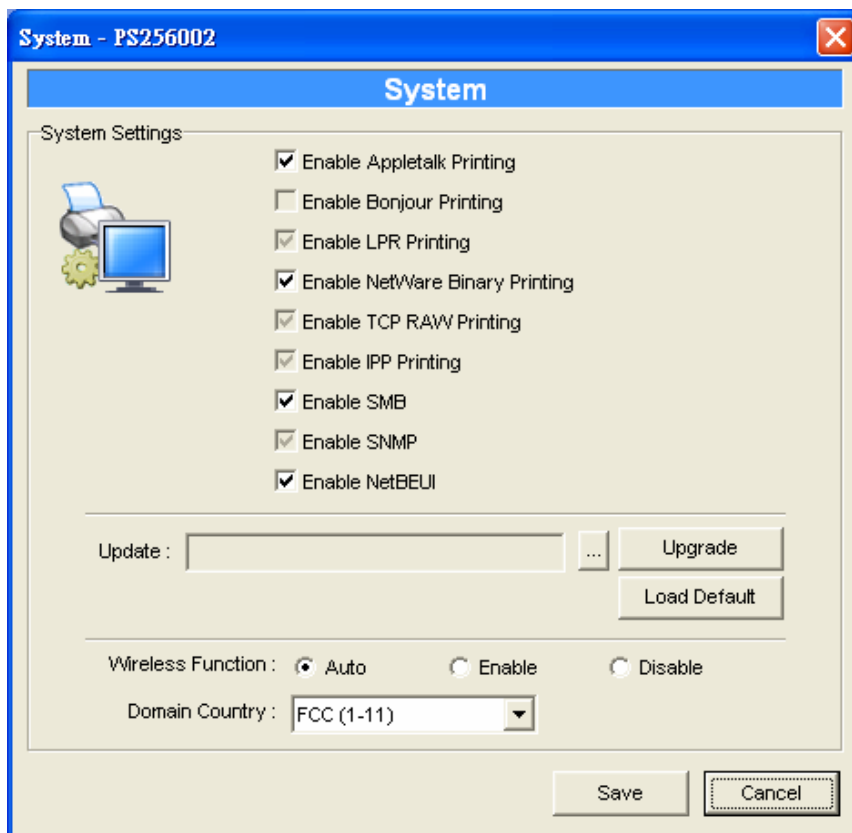

Double Click “System” icon and the System configuration window will pop-up.

In the System configuration page, you can select to enable/disable each printing or management protocol, assign name for each printer port of this print server, upgrade the new firmware for this print server, and enable/disable wireless function.

Upgrade Firmware: You can use this “Upgrade Firmware” tool to update the newest firmware of the print server.

Click “...” button and select the correct firmware in your PC. After selecting the firmware file, click the “Upgrade” button to finish the firmware update process.

Note that before you upgrade the firmware please make sure that the IP Address settings of the print server are in the same network as your computer.

Load Default: If you want to reset the Print Server to default factory settings, please click “Load Default”.

Wireless Function: You can select “Auto”, “Enable” or “Disable” to manually configure the wireless function.

Auto – “Auto” is the default setting of the print server. At this mode, the print server will automatically decide to enable or disable the wireless function. When the print server starts up, it will auto-detect if the LAN port is connected to an active network by an Ethernet cable. If this is the case, the print server will run in Ethernet mode. If the print server is not connected to an active network by Ethernet cable, the print server will run in wireless LAN mode.

Users can plug the Ethernet cable to the print server at the first, after configuring the print server features and wireless settings; they can unplug the Ethernet cable to enable the wireless connection. It makes the configuration much easier without creating the wireless connection in advance.

Note: After you have set the wireless function, please remove the Ethernet cable and then re-plug the power jack of the print server to activate the wireless connection.

Enable – Enable wireless function only, the print server’s wireless LAN will be always enabled and Ethernet will be always disabled.

Disable – Disable the wireless function, the print server’s wireless LAN will be always disabled and Ethernet will be always enabled.

Domain Country: The wireless channels are different from country to country. Generally, the channels are from 1 to 11 in USA and from 1 to 13 in Europe. The operating channel will be set to the print server before importing. If you are in different country, please make sure you have set the available channels according to your location.

7.12 Wireless Configuration

If you want to use the print server through wireless LAN, please set up the print server through Ethernet first and make sure your wireless LAN setting is correct. After setting the wireless LAN, unplug the Ethernet cable and restart the print server, then you can start to use the print server through wireless LAN. If the wireless configuration does not work, please plug the Ethernet cable again, restart the print server and configure the print server through Ethernet until the wireless LAN settings are correct.

The default settings of the print server wireless function are as follows.

- **Mode: Ad-Hoc**
- **SSID: Default**
- **Channel: 11**

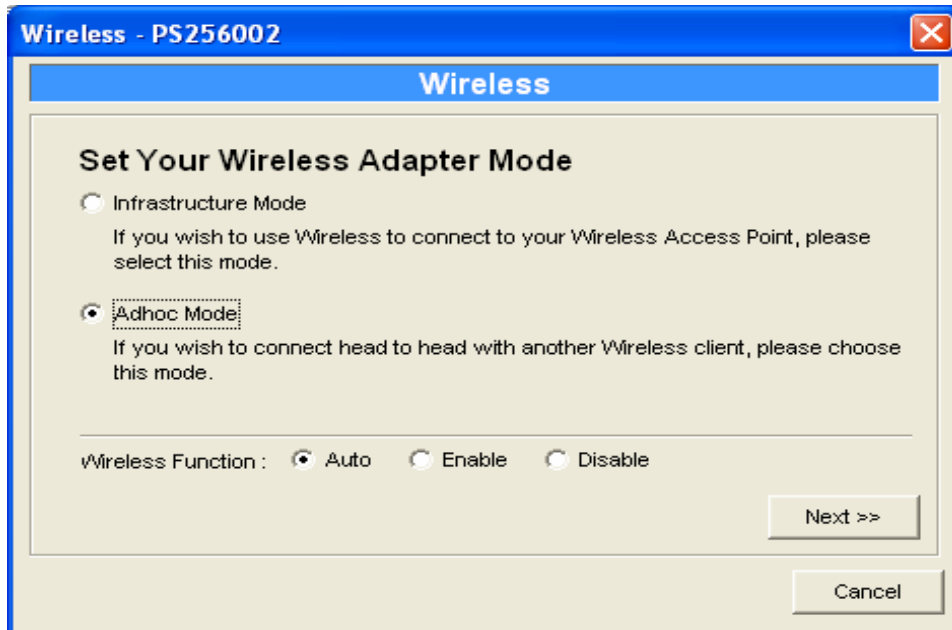

Double Click “Wireless” icon and the wireless configuration window will pop-up.

If you use access point to build up wireless network, you have to select “Infrastructure Mode”. If you do not have any access point and want to use peer-to-peer connection to build up wireless network, you have to select “Ad-Hoc Mode”.

For the “Wireless Function” setting, you can select “Auto”, “Enable” or “Disable” to manually configure the wireless function of the print server.

Auto – “Auto” is the default setting of the print server. At this mode, the print server will automatically decide to enable or disable the wireless function. When the print server starts up, it will auto-detect if the LAN port is connected to an active network by an Ethernet cable. If this is the case, the print server will run in Ethernet mode. If the print server is not connected to an active network by Ethernet cable, the print server will run in wireless LAN mode.

Users can plug the Ethernet cable to the print server at the first, after configuring the print server features and wireless settings; they can unplug the Ethernet cable to enable the wireless connection. It makes the configuration much easier without creating the wireless connection in advance.

Note: After you have set the wireless function, please remove the Ethernet cable and then re-plug the power jack of the print server to activate the wireless connection.

Enable – Enable wireless function only, the print server’s wireless LAN will be always enabled and Ethernet will be always disabled.

Disable – Disable the wireless function, the print server’s wireless LAN will be always disabled and Ethernet will be always enabled.

After selecting the operation modes of the wireless function and setting the wireless function, click “Next” to go to further detailed configuration.

Infrastructure Mode:

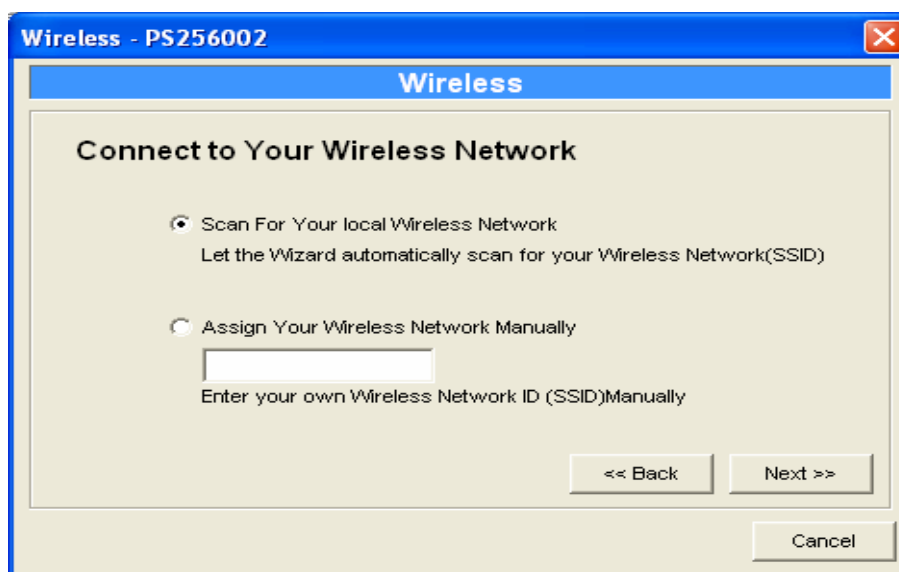

In the Infrastructure mode, you have to let the print server associate with an access point. You let the print server scan for an available access point automatically or manually assign the SSID of the access point you want to use.

If you select to let the print server scan for an available access point, the following window will pop up.

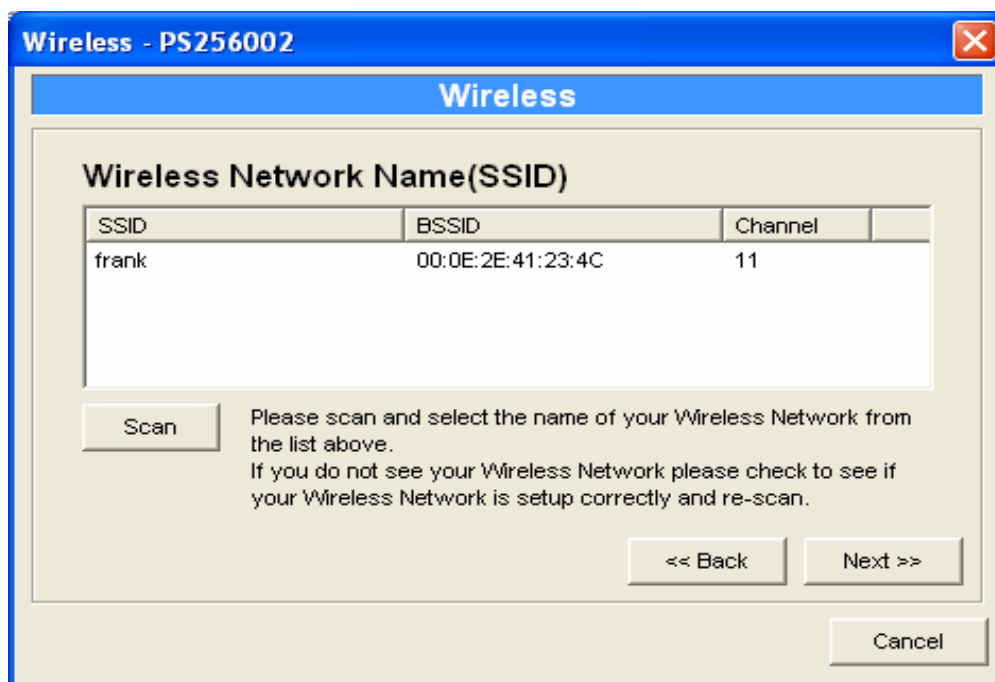

The list is the scanned available access points. Select an access point in the list and click "Next". If you cannot find the access point that you want to use, click "Scan" to let the print server scan again.

Ad Hoc Mode:



In the Ad-Hoc mode, you can let the print server automatically associate with other wireless station or manually assign the SSID of your wireless network. You can let the print server automatically select the channel that is the same with the peer or manually assign a channel.

If you select to let the print server scan for an active wireless station, the following window will pop up.

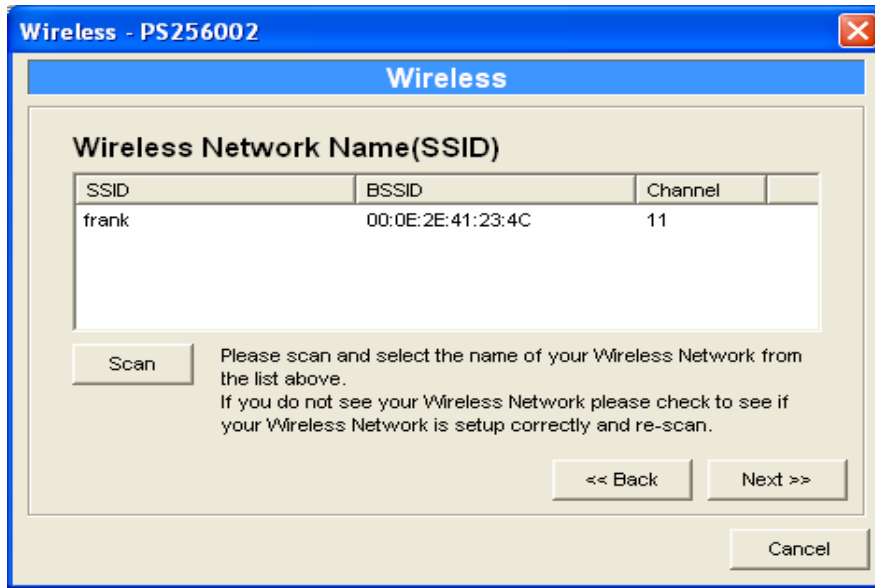

The list is the scanned active wireless stations. Select a wireless station in the list and click “Next”. If you cannot find the wireless station that you want the print server to communicate with, click “Scan” to let the print server scan again.

Both “Infrastructure” and “Ad-Hoc” mode have to go through the following procedure:

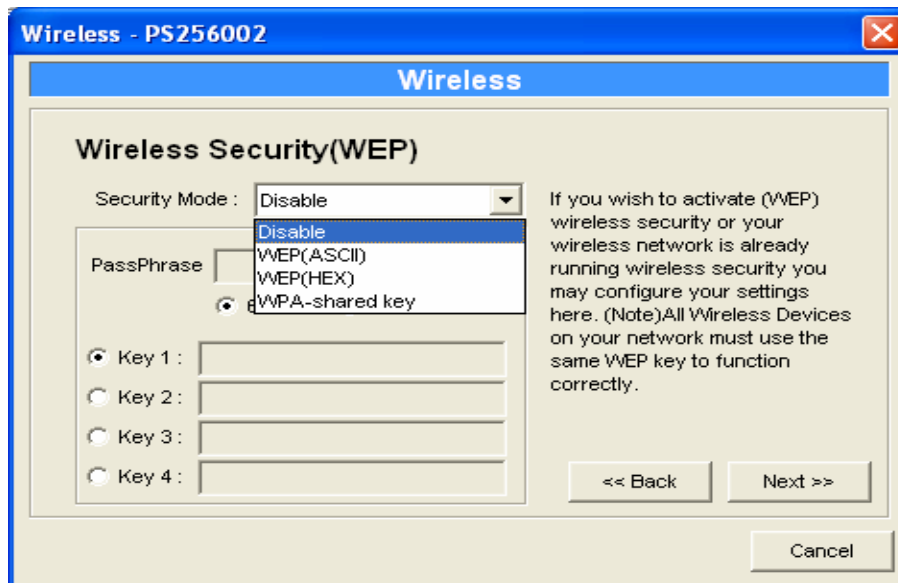

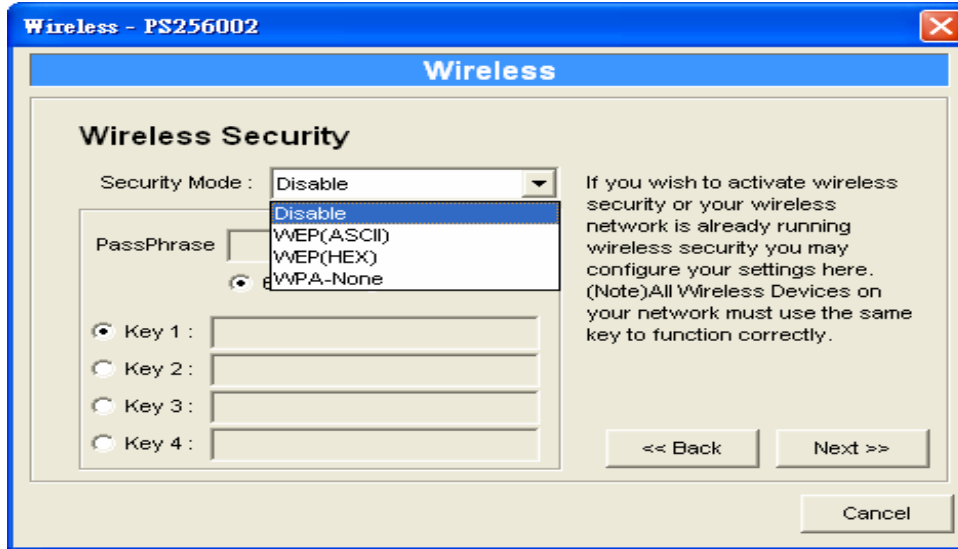

This print server supports WEP and WPA-PSK security mode. If you want to use WEP encryption to protect your wireless network, you have to select “WEP(ASCII)” or “WEP(HEX)”. If you want to use WPA-PSK, you have to select “WPA-shared key” or “WPA-None” specified for Ad Hoc mode. The wireless security setting should be the same with other wireless devices in the same network.

WEP Security Mode:

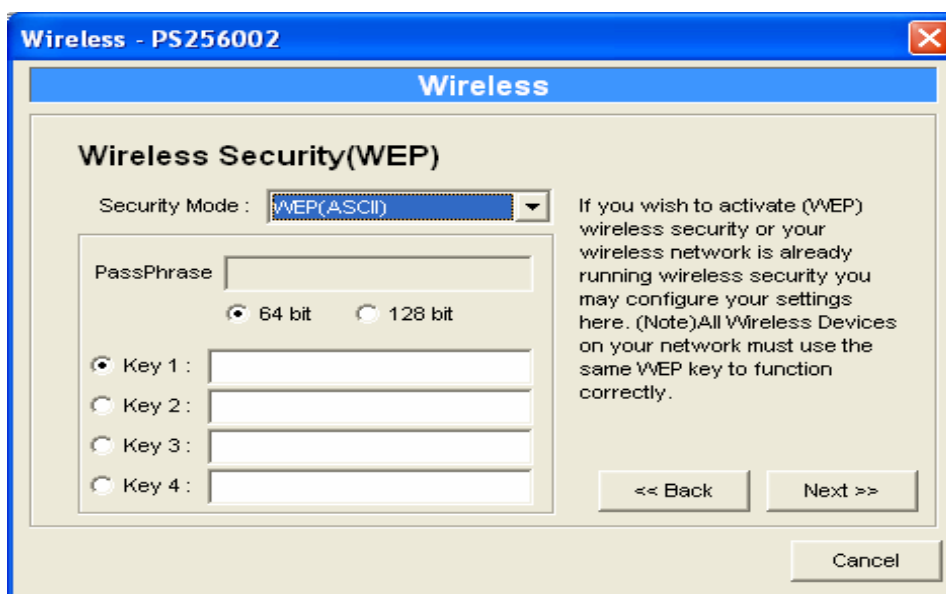

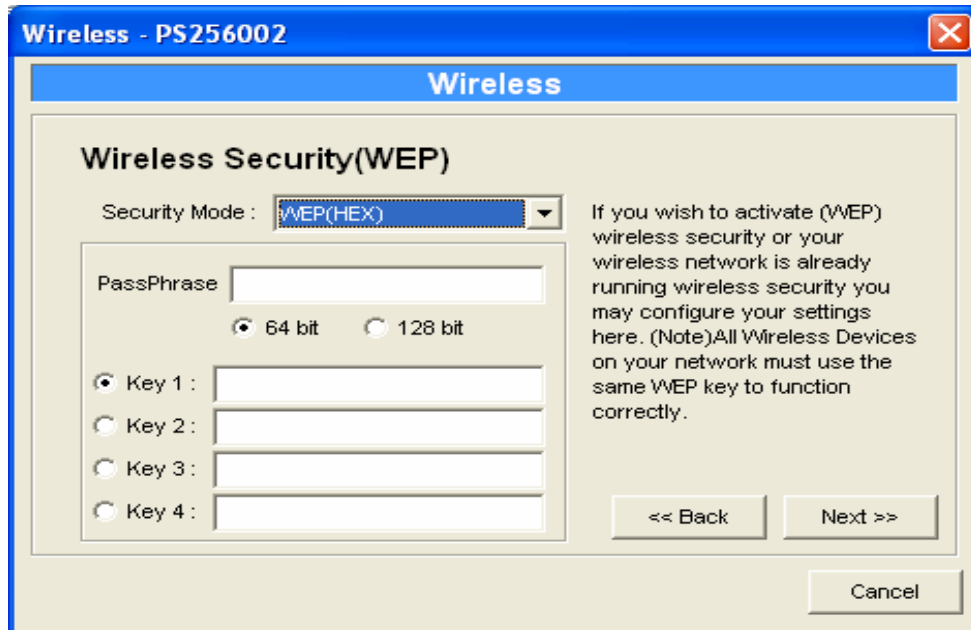

You can select “64 bit” or “128 bit” length and “Hexadecimal” or “ASCII” format for the encryption key. Longer key length can provide stronger security but worth communication performance.

Enter four key values by following the rules below and select one key as the default key.

PassPhrase – A passphrase simplifies the WEP encryption process by automatically generating the WEP encryption keys for the print server. This setting is only valid when the security mode is in “WEP(HEX)”.

Key 1 to Key 4 – If the key length is 64-bit, enter 10-digit Hex values or 5-digit ASCII values as the encryption keys. For example: “0123456aef” or “Guest”.

If the key length is 128-bit, enter 26-digit Hex values or 13-digit ASCII values as the encryption keys. For example: “01234567890123456789abcdef” or “administrator”.

WPA-shared key or WPA-None Security Mode:

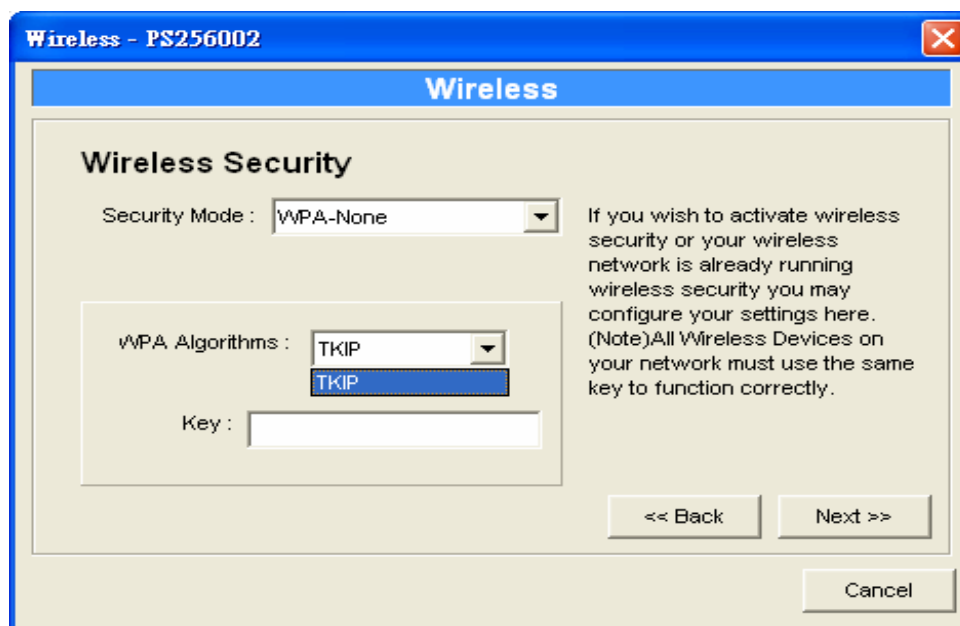
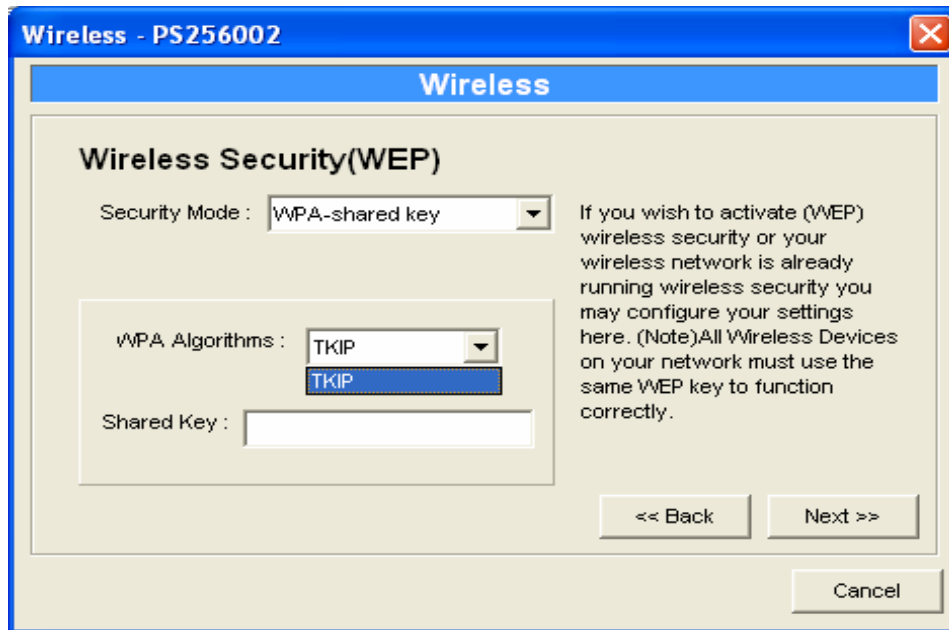

“WPA-shared key” (for an infrastructure network) or “WPA-None” (enables WPA security for your ad hoc network) requires users to set the advanced encryption methods, i.e. TKIP and enter a set of shared key.

TKIP – TKIP (Temporal Key Integrity Protocol) changes the temporal key every 10,000 packets. This insures much greater security than the standard WEP security.

Shared Key – Enter 8 to 63 digits of ASCII format to be the key for the authentication within the network.

When you finish configuring the wireless security, click “Next” to go to next step.



You can select to let the print server automatically obtain IP settings with DHCP client or manually assign the IP settings.

If you manually assign the IP settings, you have to enter IP address, subnet mask and default gateway address.

When you finish configuring the IP settings, click “Next” to confirm the IP Address configuration.

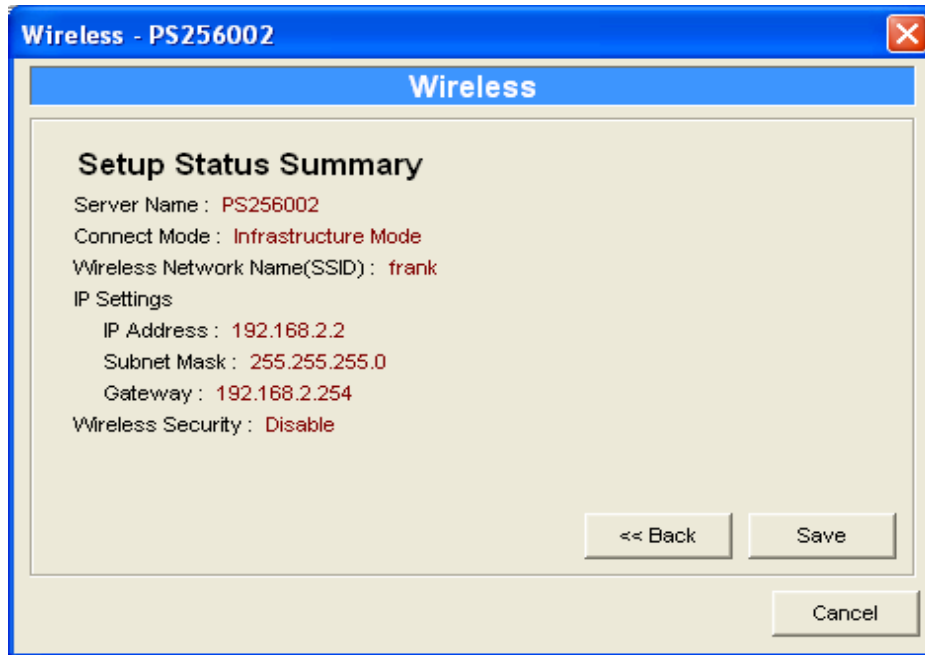

Click “Save” to save the wireless configuration.

7.12 Wizard

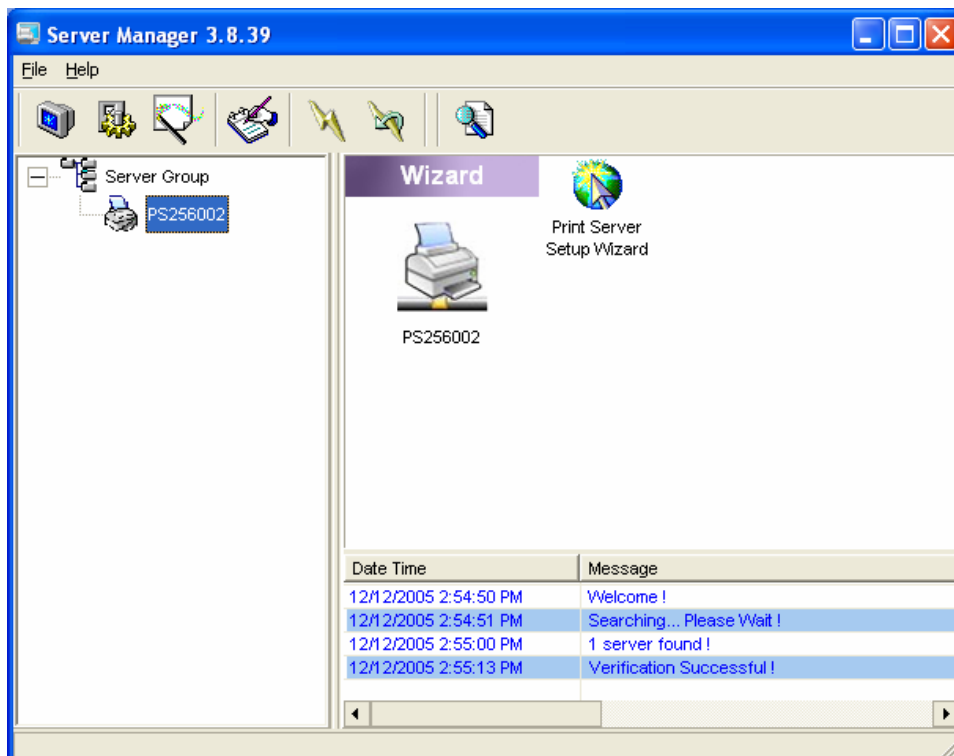

Click “Wizard” icon  on the tool bar, the setup wizard item of the current selected print server will be showed on the right side of the window.

Double click the “Print Server Setup Wizard” the setup wizard will guide you through all the setup process.

Step 1: Set up the name of this print server and select to enable or disable the wireless function.

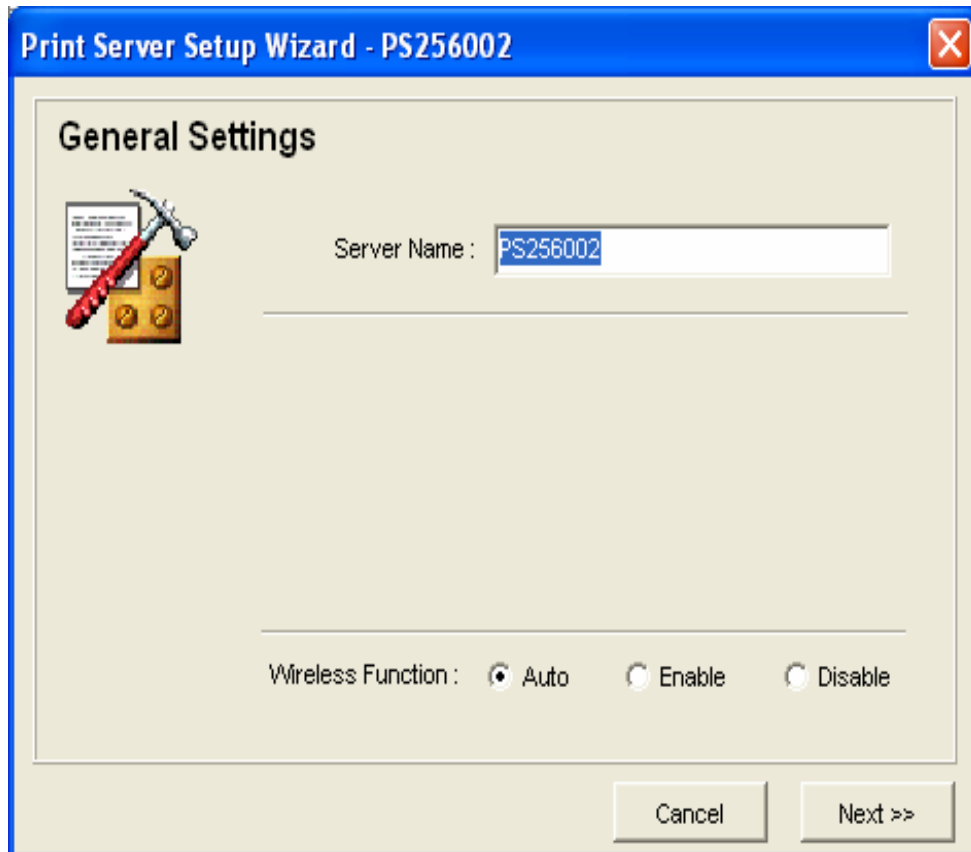

Step 2: Select to enable required printing protocol. Please refer to section 7.11 for detail information.

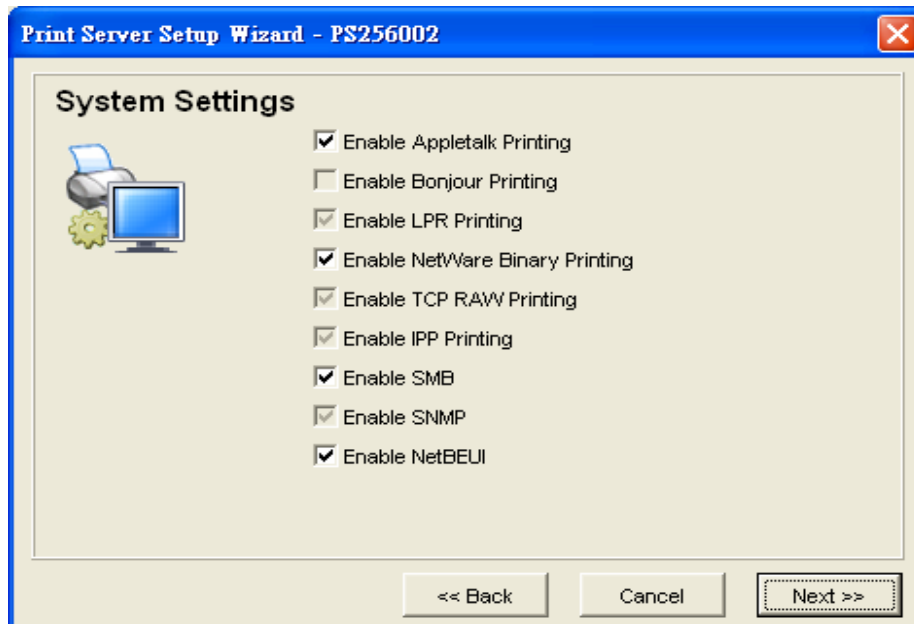

Step 3: Setup the IP of this print server and the DHCP server. Please refer to section 7.6 for detail information.

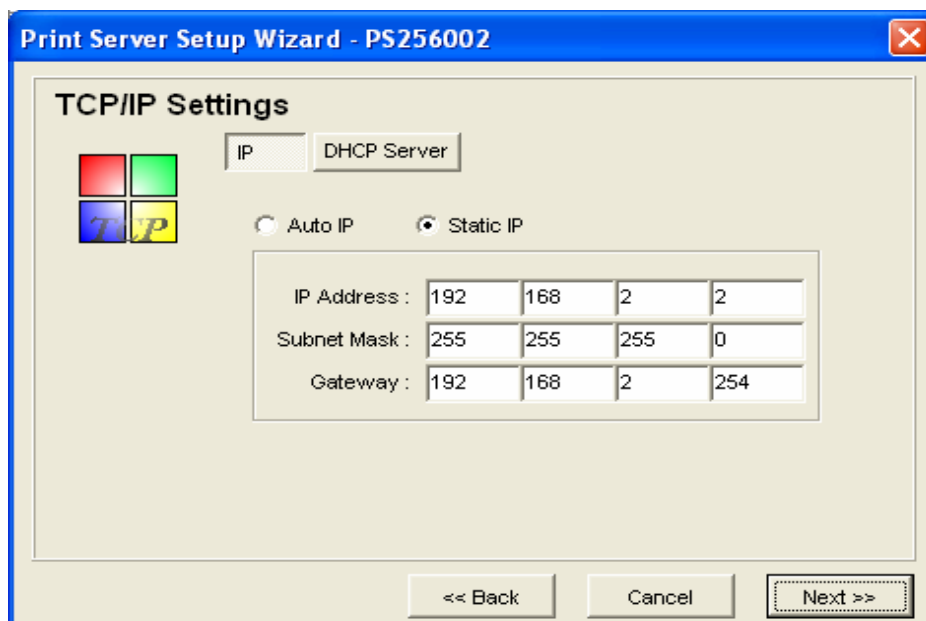

Step 4: Setup the AppleTalk printing. Please refer to section 7.8 for detail information.



Step 5: Setup the NetWare printing. Please refer to section 7.7 for detail information.

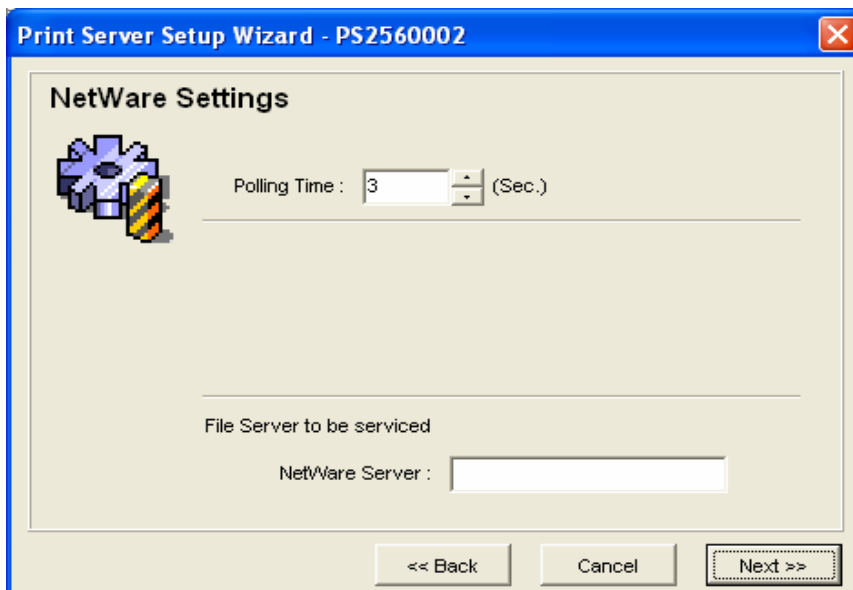

Step 6: Select the Wireless Adapter mode and complete wireless LAN settings. The other procedures are the same with “Wireless” Setting in “Setup” screen. Please refer to section 7.12 for detail information.



Step 7: Click “Save” to finish setting. Please reboot the print server to let these settings take effect.

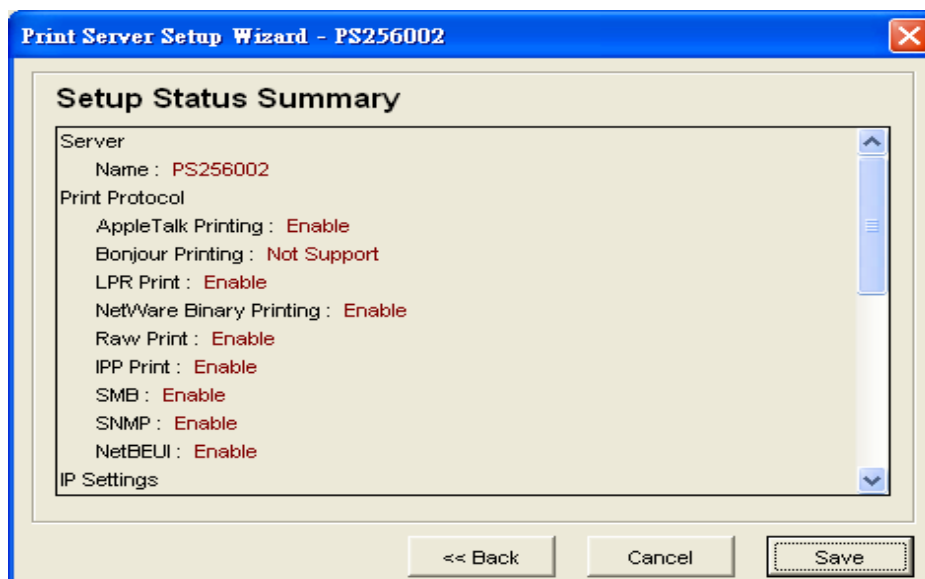

8. Web Management

8.1 Introduction

Print server can be configured and managed on the Web. Through Local Area Network, or even Internet, administrator can easily configure and manage print server's various main functions in browsers. Simply enter print server's IP address into your browser's address field to manage a print server by print server's built-in Web Server.

The default IP Address, User Name and Password settings of the Print server are as follows.

IP Address: 192.168.2.2

User Name: Admin

Password: 1234

8.2 Login

You may use any Web Browser to review the status or configure the settings of the print server. After entering the IP address of the print server, a login page display. You have to enter correct “User Name” and “Password” before going to the Web Management pages.

Notes: Default User Name is “admin”, default password is “1234”.



Connect to 192.168.2.2

Default password:1234

User name: admin

Password: ●●●●●

Remember my password

OK Cancel

8.3 Device Status

8.3.1 System

The screenshot shows a Microsoft Internet Explorer browser window displaying the 'Print Server' status page. The address bar shows 'http://192.168.2.2/'. The page title is 'Print Server'. Below the title, there are navigation links: 'Device Setup', 'Setup Wizard', and 'System Tools'. The main content area is titled 'STATUS SYSTEM' and contains a table of system settings. The table is organized into sections: 'System Information' and 'Wireless Configuration'. The 'System Information' section lists various settings such as Device Name, Printer Server Name, Model Type, Firmware Version, MAC Address, USB Port Number, LPT Port Number, and Wireless Lan Status. The 'Wireless Configuration' section lists settings like Mode, Channel Number, Status, ESSID, WEP, and BSSID. The status of each setting is indicated as 'Enable', 'Disable', or 'Auto'. The browser's status bar at the bottom shows 'Done' and 'Internet'.

System Information			
Device Name :	PS031727	Raw Printing :	Enable
Printer Server Name :	PS256002	IPP Printing :	Enable
Model Type :	1PW Print Server	LPR Printing :	Enable
Firmware Version :	3.1.23	AppleTalk Printing :	Disable
MAC Address :	00:00:B4:03:17:27	NetWare Printing :	Disable
USB Port Number :	No	SMB :	Disable
LPT Port Number :	1	SNMP :	Enable
Wireless Lan Status :	Auto	NetBEUI :	Disable

Wireless Configuration			
Mode :	Adhoc	ESSID :	00:00:00:00:00:00
Channel Number :	0	WEP :	Disable
Status :	Disconnected	BSSID :	

System Information includes “Device Name”, “Print Server Name”, “Model Type”, “Firmware Version”, “MAC Address”, “Wireless LAN Configuration” and the protocols enabled status, etc.

8.3.2 Printer

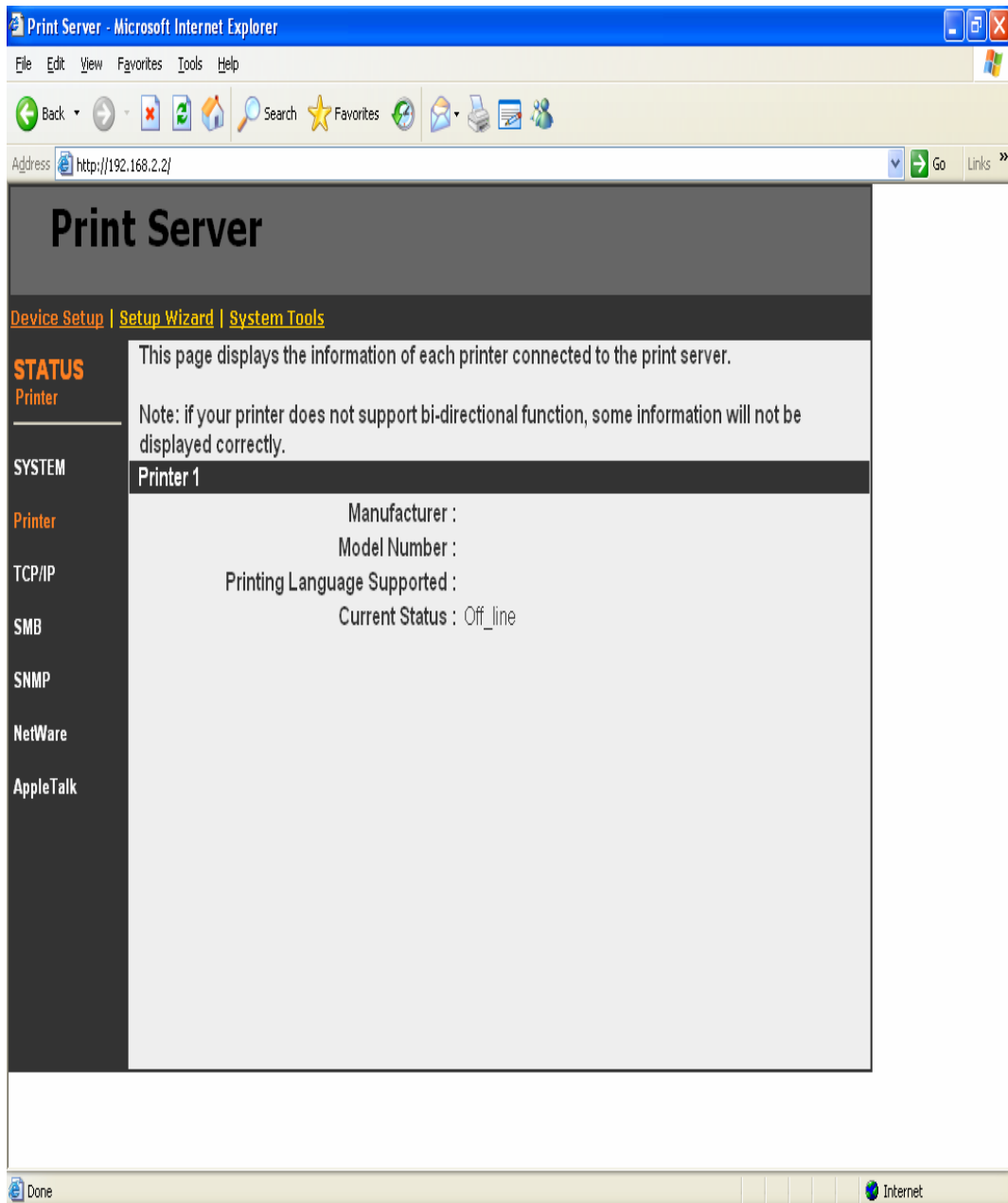

This page lists information of printers connected to all printer ports.

8.3.3 TCP/IP

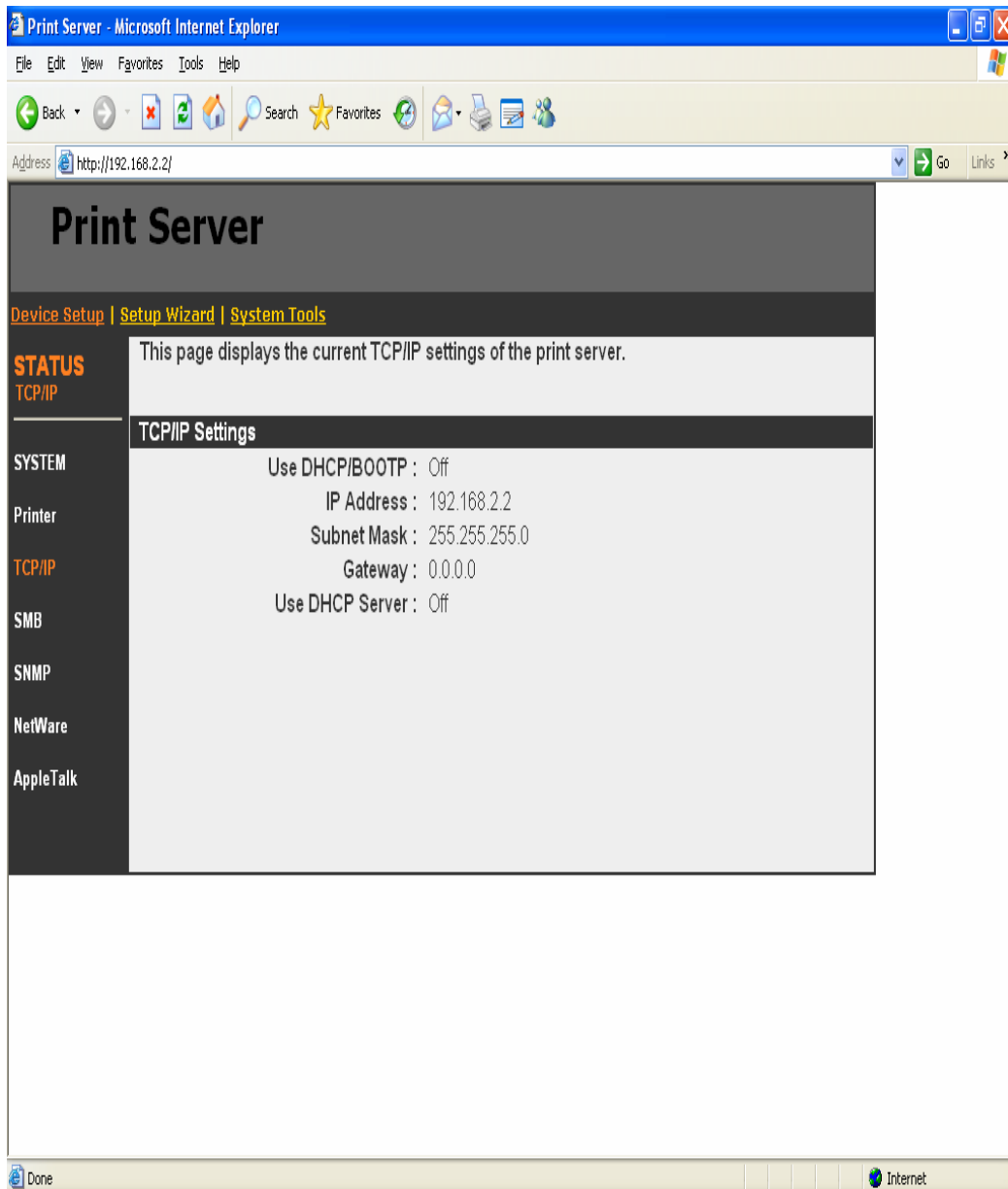

This page lists all TCP/IP settings of the print server including “IP Address”, “Subnet Mask” and “Gateway”. It also lists DHCP server setting.

8.3.4 SMB

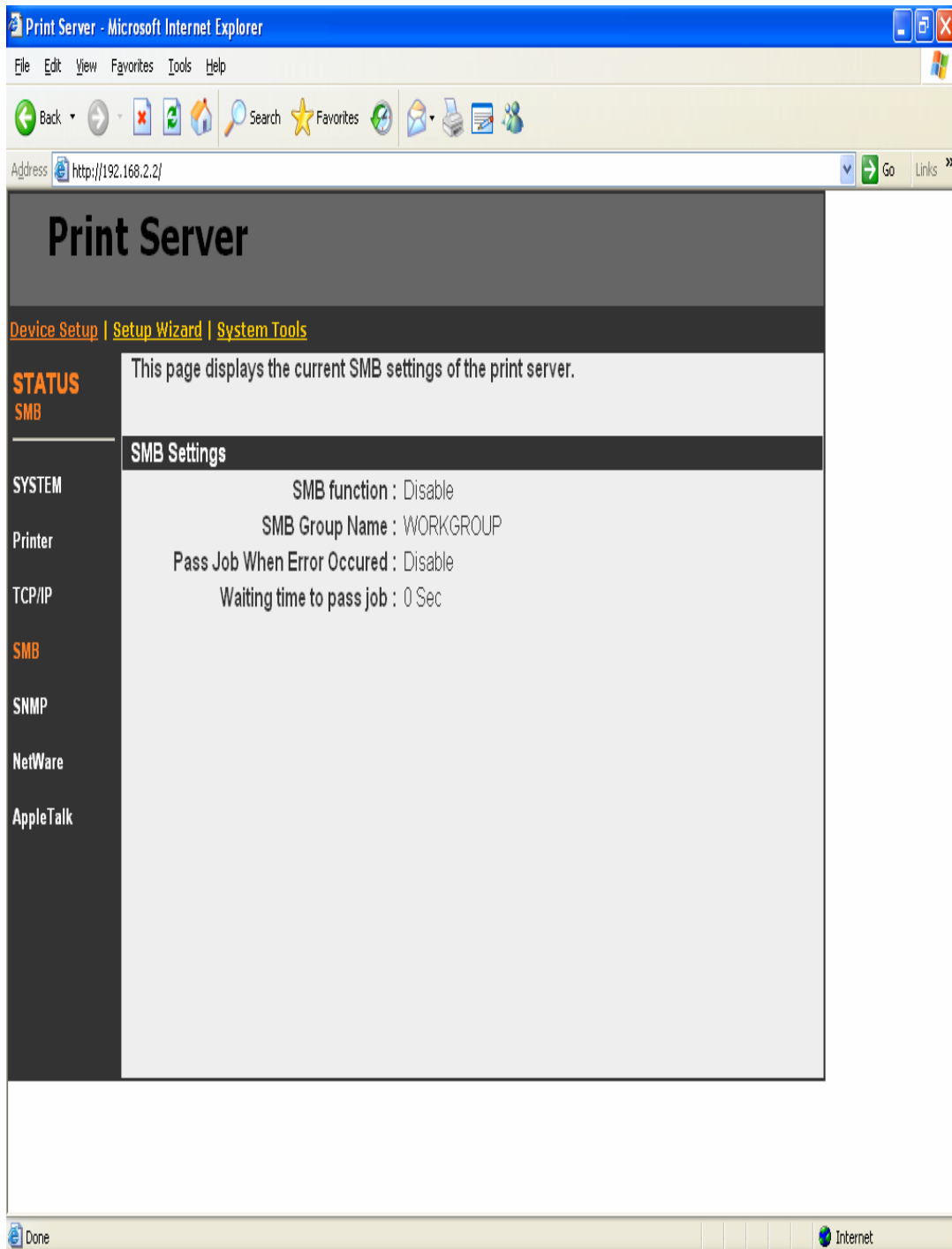

This page lists the SMB group and the pass job interval time settings of the print server.

8.3.5 SNMP

The screenshot shows a Microsoft Internet Explorer browser window titled "Print Server - Microsoft Internet Explorer". The address bar displays "http://192.168.2.2/". The main content area is titled "Print Server" and contains a navigation menu with links for "Device Setup", "Setup Wizard", and "System Tools". A sidebar on the left lists various system settings: "STATUS", "SYSTEM", "Printer", "TCP/IP", "SMB", "SNMP", "NetWare", and "AppleTalk". The "SNMP" option is highlighted in orange. The main content area displays the following text:

This page displays the current SNMP settings of the print server.

SNMP Settings

SNMP System Contact : None
SNMP System Location : None

The browser's status bar at the bottom shows "Done" and "Internet".

This page lists the SNMP settings of the print server. It includes the settings of “SNMP System Contact” and “SNMP System Location”.

8.3.6 NetWare

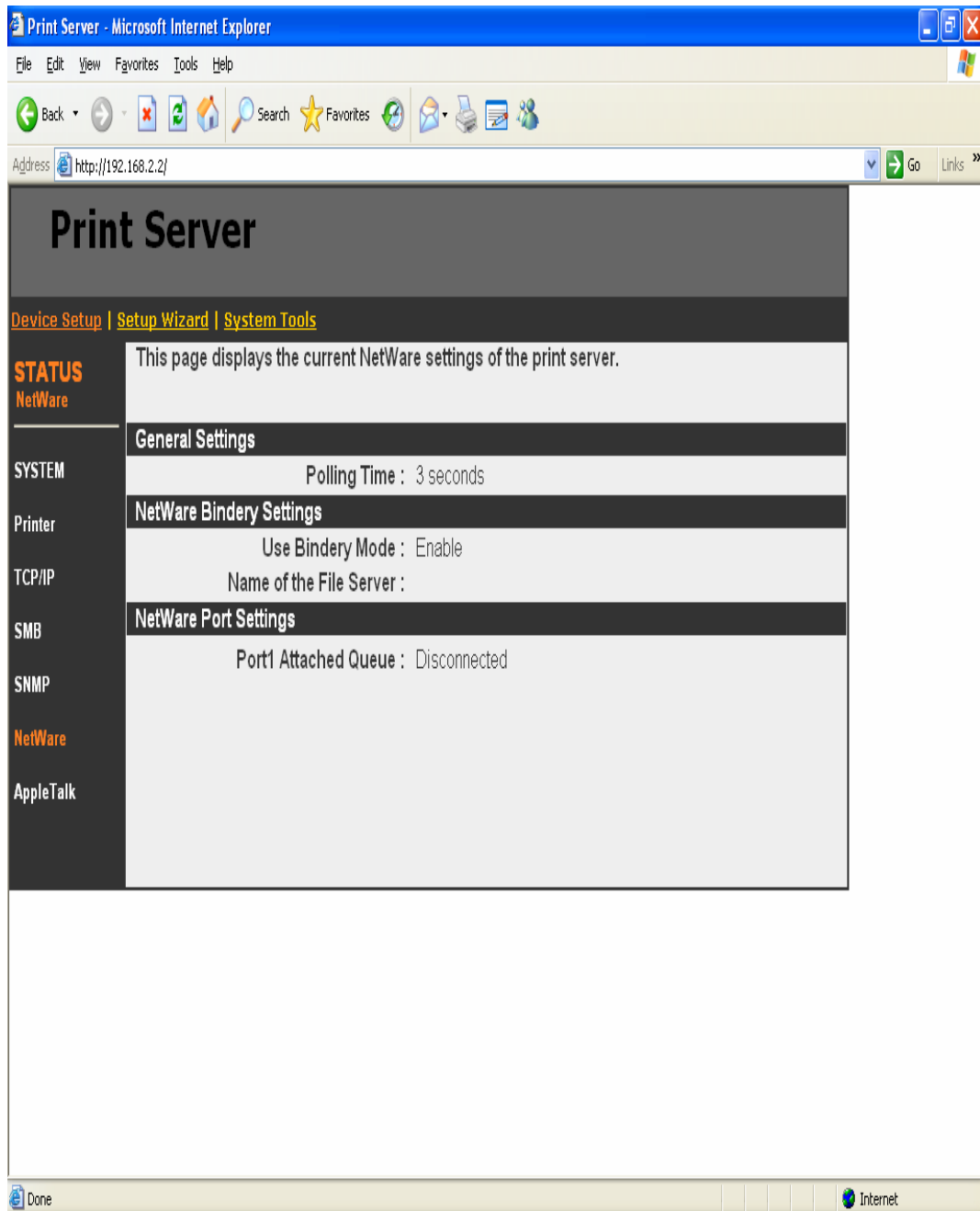

This page lists NetWare settings, including “Polling Time”, “Use Bindery Mode”, “Name of the File Server” and “Port Attached Queue”.

8.3.7 AppleTalk

The screenshot shows a Microsoft Internet Explorer browser window titled "Print Server - Microsoft Internet Explorer". The address bar displays "http://192.168.2.2/". The main content area features a dark header with the text "Print Server". Below the header, there are navigation links: "Device Setup", "Setup Wizard", and "System Tools". A sidebar on the left lists various system settings: "STATUS", "AppleTalk", "SYSTEM", "Printer", "TCP/IP", "SMB", "SNMP", "NetWare", and "AppleTalk". The main content area displays the following information:

- This page displays the current AppleTalk settings of the print server.
- AppleTalk Settings**
- AppleTalk Zone Name : *
- Printer 1**
- Printer Type : LaserWriter

The browser's status bar at the bottom shows "Done" and "Internet".

This page lists AppleTalk settings, including “AppleTalk Zone Name” and “Printer Type” of printers connected to all print ports.

8.4 Setup Wizard

8.4.1 System

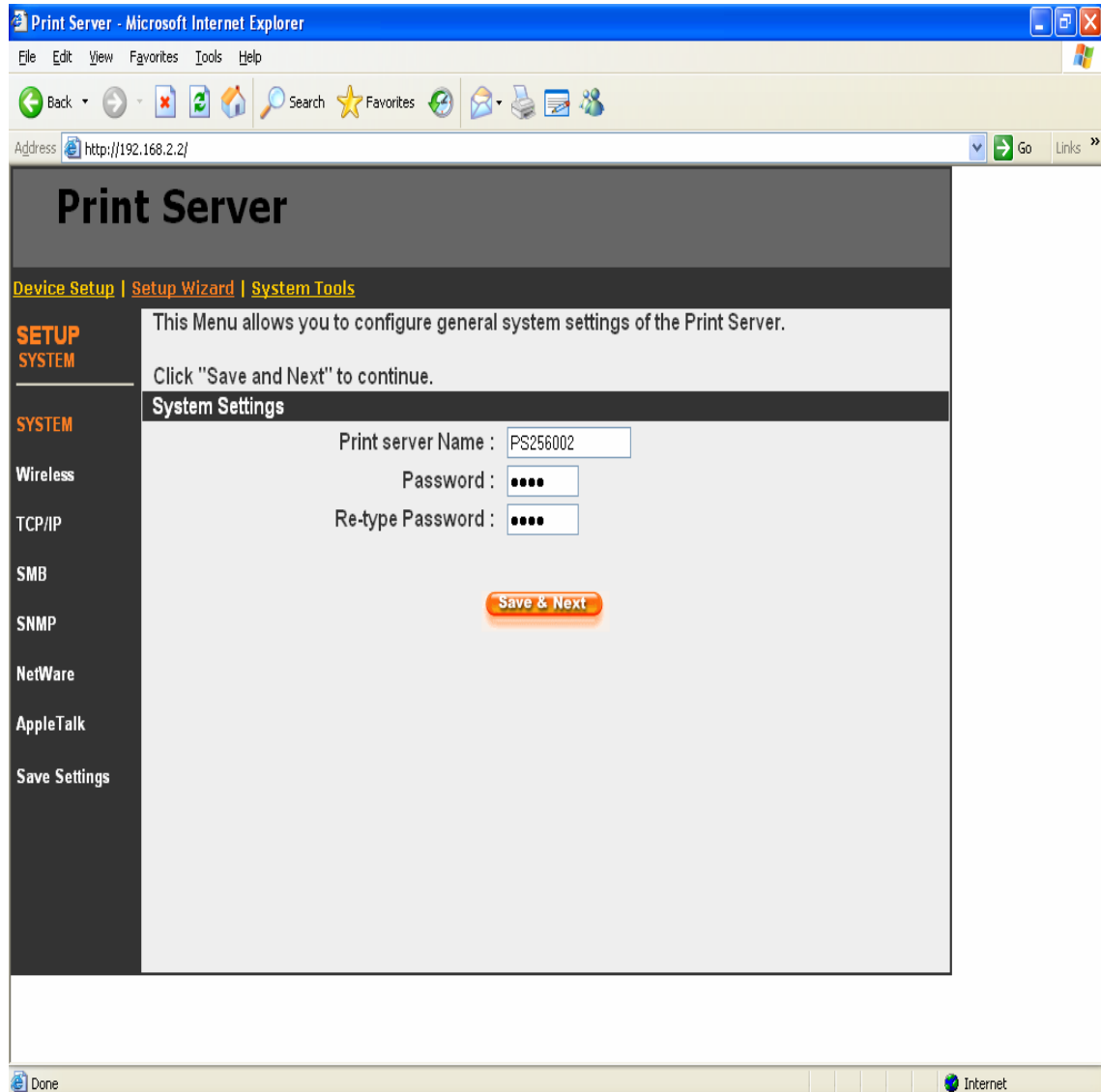

You can change the print server name and password of the print server from here.

Print Server Name, the name of the print server. You can use this name to identify the print server when you are searching for the print server by the administration and client utilities.

Password, enter the password you want to change to the print server. The password can be up to 7-digit alphanumeric format. The default password is “1234”.

Re-type Password, enter the password you want to change to the print server again.

8.4.1.1 Advanced Settings

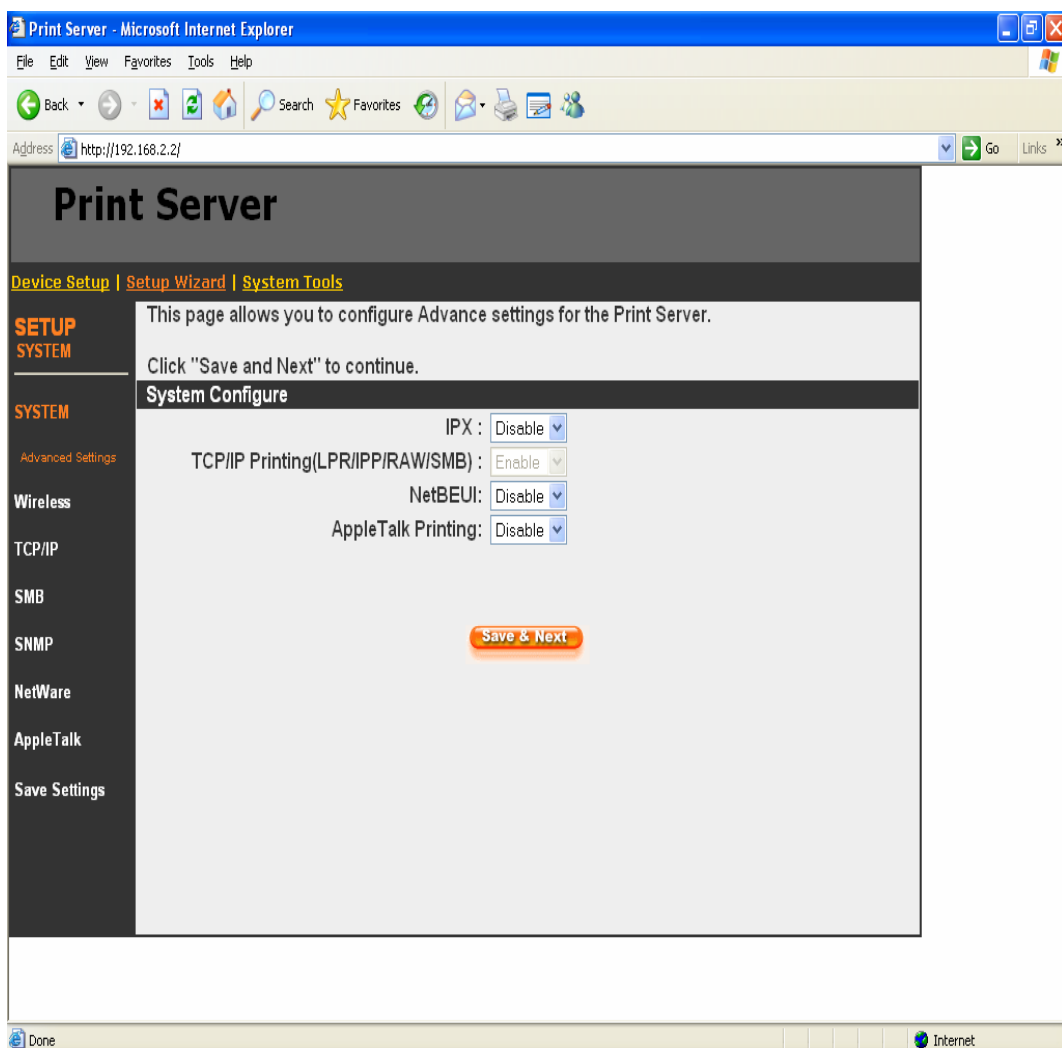

You can enable/disable the printing protocols from the screen. To enable the function, please select “Enable”; to disable the function, please select “Disable”.

8.4.2 Wireless

If you want to use the print server through wireless LAN, please set up the print server through Ethernet first and make sure your wireless LAN setting is correct. After setting the wireless LAN, unplug the Ethernet cable and restart the print server, then you can start to use the print server through wireless LAN. If the wireless configuration does not work, please plug the Ethernet cable again, restart the print server and configure the print server through Ethernet until the wireless LAN settings are correct.

8.4.2.1 General Setting

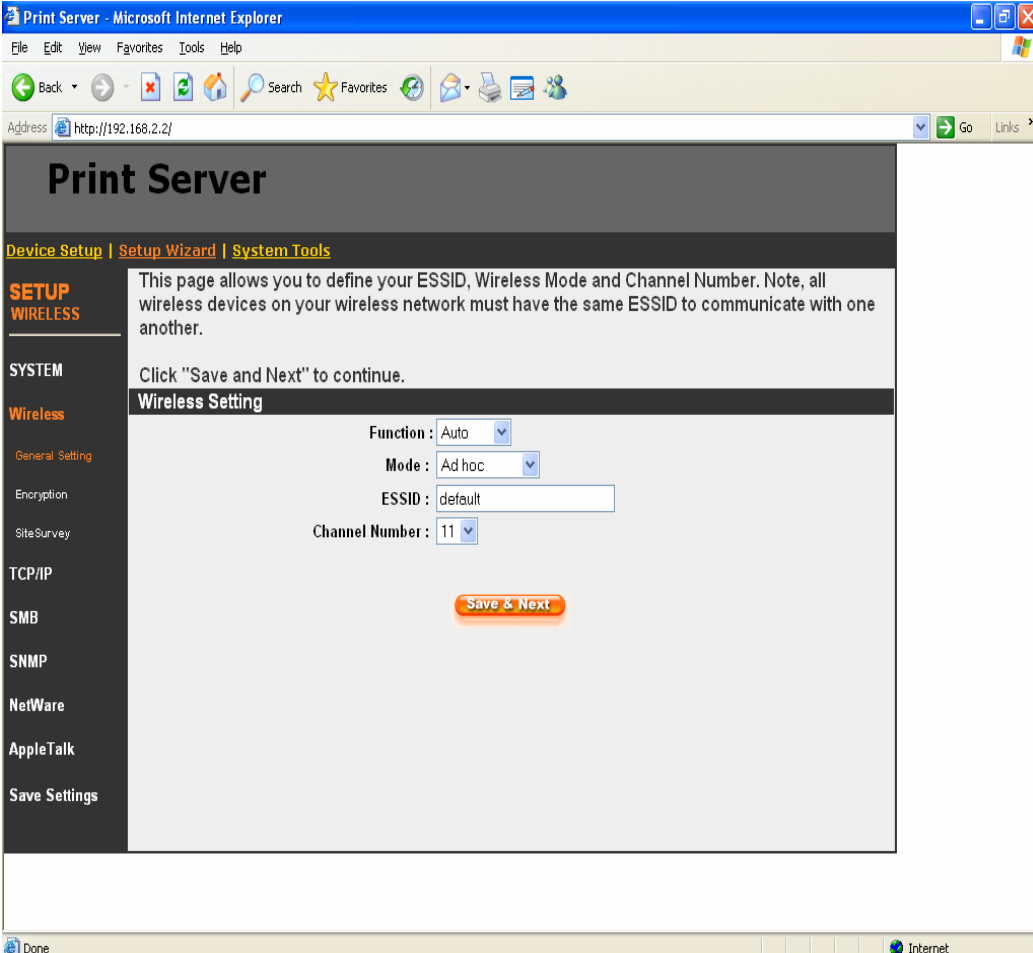

The screenshot shows a web browser window titled "Print Server - Microsoft Internet Explorer" with the address bar displaying "http://192.168.2.2". The main content area is titled "Print Server" and contains a navigation menu with links for "Device Setup", "Setup Wizard", and "System Tools". The "Setup Wizard" section is active, showing "SETUP WIRELESS" and "SYSTEM" options. Under "SYSTEM", the "Wireless" option is selected, leading to the "Wireless Setting" page. This page provides instructions: "This page allows you to define your ESSID, Wireless Mode and Channel Number. Note, all wireless devices on your wireless network must have the same ESSID to communicate with one another." Below the instructions, there is a "Click 'Save and Next' to continue." prompt. The "Wireless Setting" form includes the following fields:

- Function: Auto (dropdown menu)
- Mode: Ad hoc (dropdown menu)
- ESSID: default (text input field)
- Channel Number: 11 (dropdown menu)

A "Save & Next" button is located below the form fields. The browser's status bar at the bottom shows "Done" and "Internet".

You can enable/disable the wireless function and set parameters that are used for the wireless stations to connect to this print server from here. The parameters include “Function”, “Mode”, “ESSID” and “Channel Number”. You can manually set the parameters of wireless LAN in this page or use the “Site Survey” function to automatically search for an available access point and associate with it.

Function is for user to disable, enable or let the print server auto select to connect to the wired or wireless network.

Auto – “Auto” is the default setting of the print server. At this mode, the print server will automatically decide to enable or disable the wireless function. When the print server starts up, it will auto-detect if the LAN port is connected to an active network by an Ethernet cable. If this is the case, the print server will run in Ethernet mode. If the print server is not connected to an active network by Ethernet cable, the print server will run in wireless LAN mode.

Users can plug the Ethernet cable to the print server at the first, after configuring the print server features and wireless settings; they can unplug the Ethernet cable to enable the wireless connection. It makes the configuration much easier without creating the wireless connection in advance.

Note: After you have set the wireless function, please remove the Ethernet cable and then re-plug the power jack of the print server to activate the wireless connection.

Enable – Enable wireless function only, the print server's wireless LAN will be always enabled and Ethernet will be always disabled.

Disable – Disable the wireless function, the print server's wireless LAN will be always disabled and Ethernet will be always enabled.

Mode is the operation mode of wireless station. You can choose either "Ad Hoc" or "Infrastructure" mode. If you do not have any access point and want to use peer-to-peer connection, you have to choose "Ad Hoc" mode. If you have an access point as the wireless LAN infrastructure, you have to choose "Infrastructure" mode.

ESSID is the unique name identified by in a wireless LAN. The ID prevents the unintentional merging of two co-located WLANs. Please make sure that the ESSID of all stations and access points in the same WLAN network are the same.

Channel Number is the channel number of your wireless LAN. Please make sure that the channel number of all stations and access points in the same WLAN network are the same.

8.4.2.2 Encryption

This print server supports WEP and WPA-PSK security mode. If you want to use WEP encryption to protect your wireless network, you have to select "WEP". If you want to use WPA-PSK, you have to select "WPA-PSK" (for an infrastructure network or "WPA-NONE" (enables WPA security for an ad hoc network). The wireless security setting should be the same with other wireless devices in the same network.

WEP Security Mode:

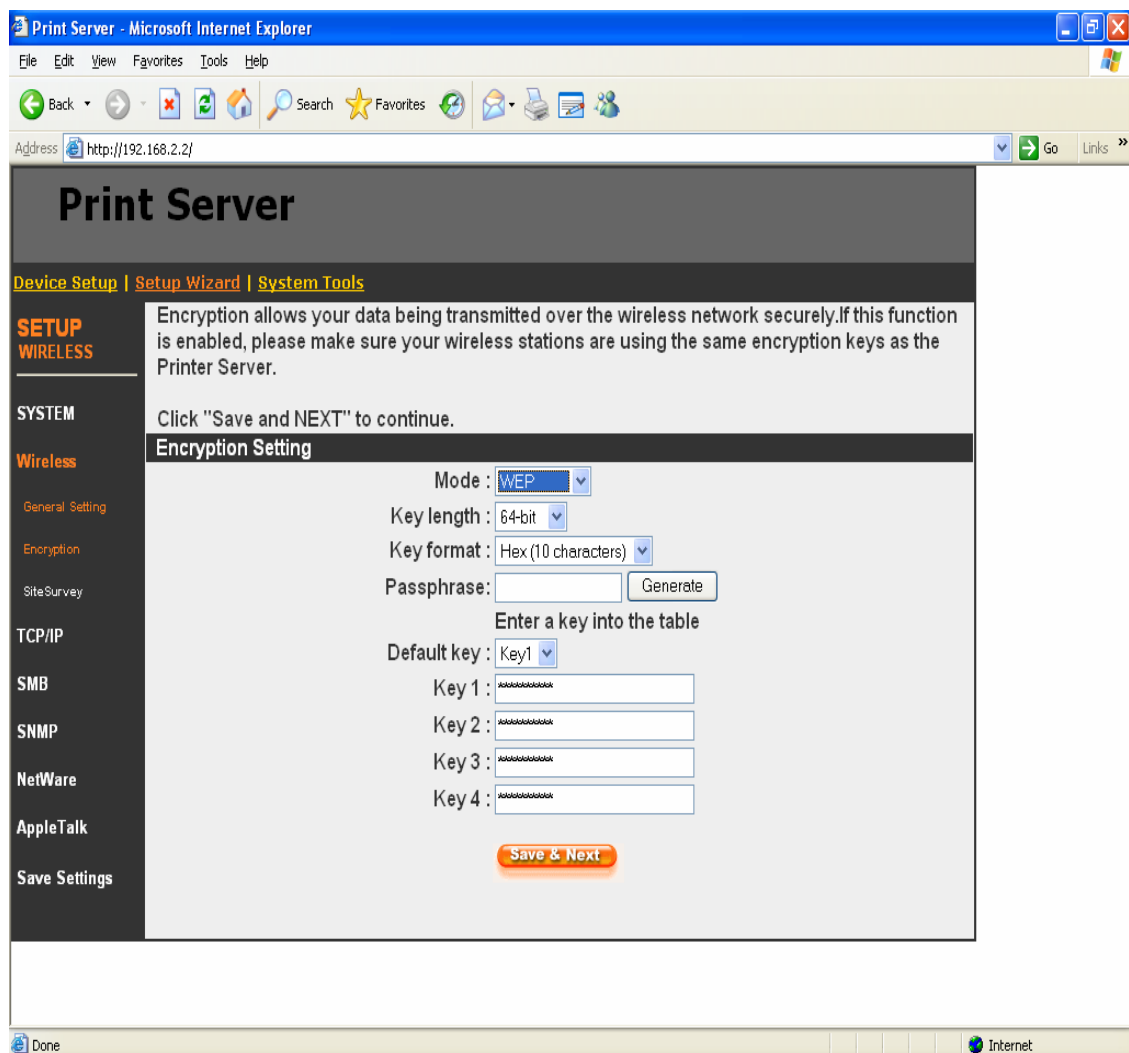

The screenshot shows a web browser window titled "Print Server - Microsoft Internet Explorer" with the address bar showing "http://192.168.2.2/". The main content area is titled "Print Server" and contains a navigation menu with "Device Setup", "Setup Wizard", and "System Tools". The "SETUP WIRELESS" section is active, and the "Encryption Setting" page is displayed. The page contains the following text and form elements:

Encryption allows your data being transmitted over the wireless network securely. If this function is enabled, please make sure your wireless stations are using the same encryption keys as the Printer Server.

Click "Save and NEXT" to continue.

Encryption Setting

Mode :

Key length :

Key format :

Passphrase :

Enter a key into the table

Default key :

Key 1 :

Key 2 :

Key 3 :

Key 4 :

Key Length – You can choose “64-bit” to use WEP with 64-bit key length encryption or choose “128-bit” to use WEP with 128-bit key length encryption. The longer key length can provide better security but worse transmission throughput.

Key Format – You may select to use ASCII Characters (alphanumeric format) or Hexadecimal digits (in the "A-F", "a-f" and "0-9" range) to be the WEP Key.

PassPhrase – A passphrase simplifies the WEP encryption process by automatically generating the WEP encryption keys for the print server.

Default Key – Select one of the four keys to encrypt your data. Only the key you select it in the “Default key” will take effect.

Key 1 – Key 4 – The WEP keys are used to encrypt data transmitted within the wireless network. Fill the text box by following the rules below.

64-bit WEP: input 10-digit Hex values (in the "A-F", "a-f" and "0-9" range) or 5-digit ASCII character as the encryption keys. For example: “0123456aef” or “Guest”.

128-bit WEP: input 26-digit Hex values (in the "A-F", "a-f" and "0-9" range) or 10-digit ASCII characters as the encryption keys. For example: “01234567890123456789abcdef” or “administrator”.

WPA-PSK or WPA-NONE Security Mode:

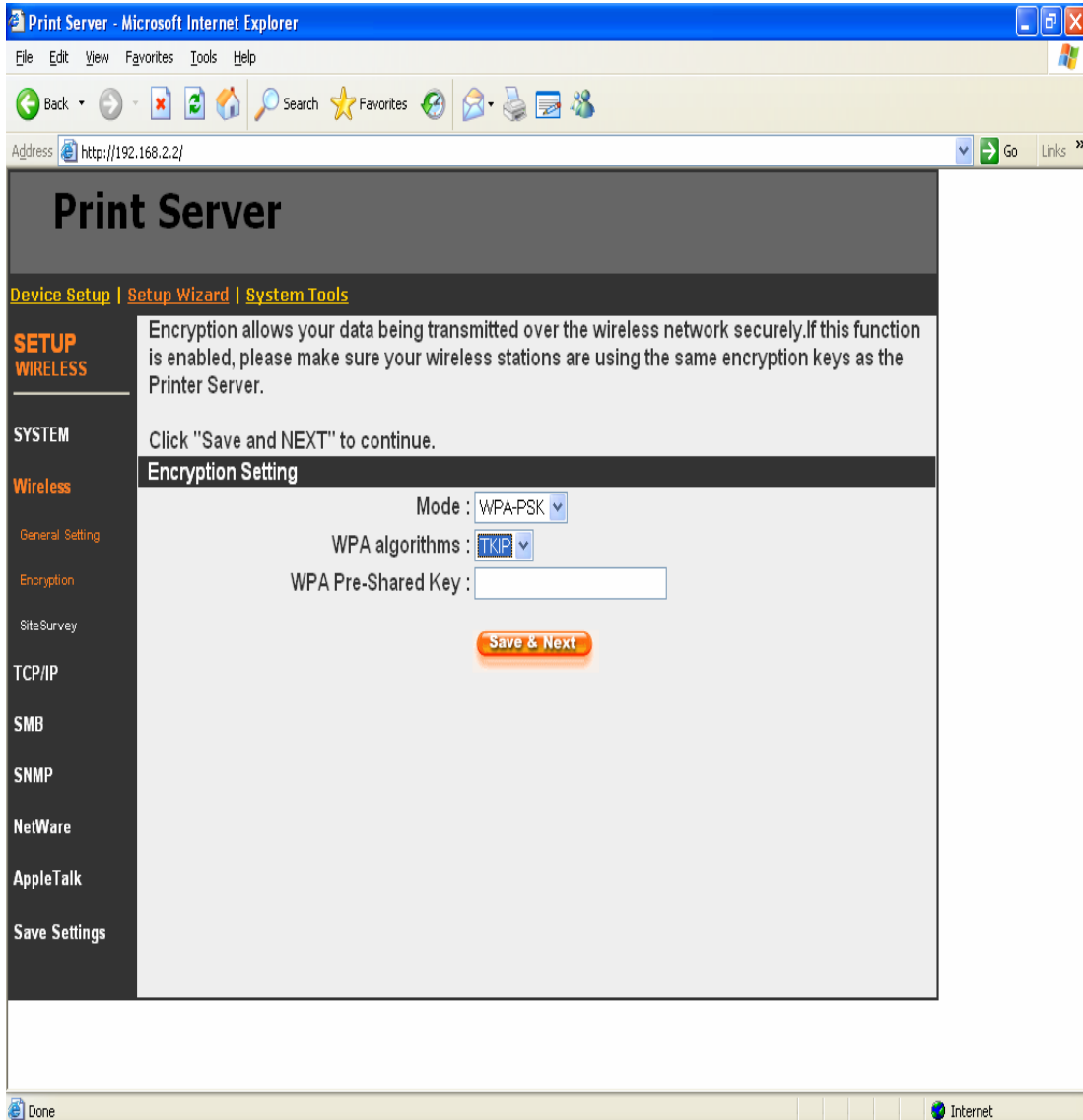

“WPA-shared key” (for an infrastructure network) or “WPA-None” (enables WPA security for your ad hoc network) requires users to set the advanced encryption methods, i.e. TKIP and enter a set of shared key.

TKIP – TKIP (Temporal Key Integrity Protocol) changes the temporal key every 10,000 packets. This insures much greater security than the standard WEP security.

WPA Pre-Shared Key – Enter 8 to 63 digits of ASCII format to be the key for the authentication within the network.

When you finish configuring the wireless security, click “Save & Next” to confirm the configuration.

8.4.2.3 Site Survey

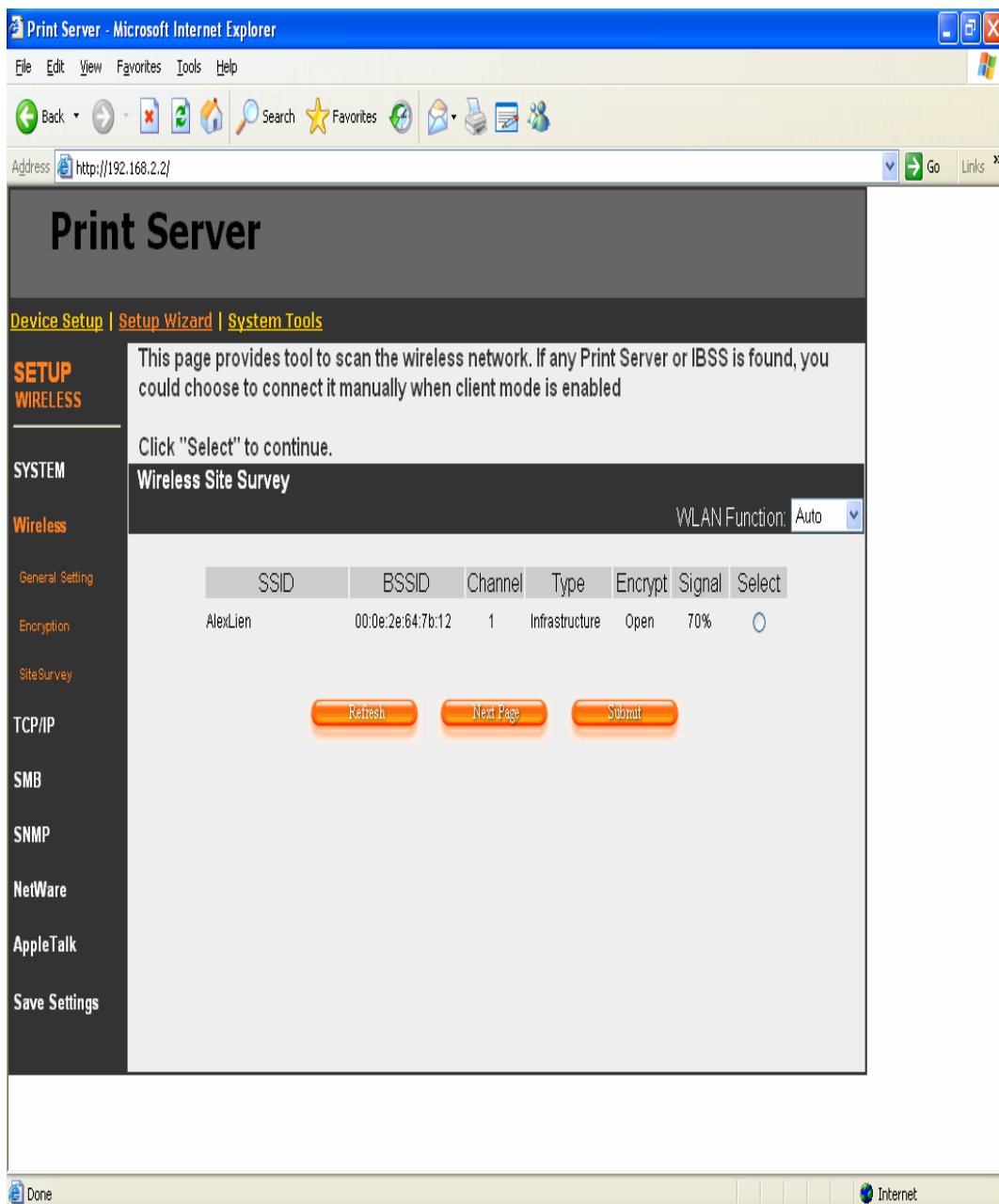

The screenshot shows a Microsoft Internet Explorer browser window displaying the Print Server web interface. The address bar shows <http://192.168.2.2/>. The page title is "Print Server". The navigation menu includes "Device Setup", "Setup Wizard", and "System Tools". The "SETUP WIRELESS" section is active, with a sub-menu for "Wireless" containing "General Setting", "Encryption", "Site Survey", "TCP/IP", "SMB", "SNMP", "NetWare", "AppleTalk", and "Save Settings". The "Site Survey" page contains the following text:

This page provides tool to scan the wireless network. If any Print Server or IBSS is found, you could choose to connect it manually when client mode is enabled

Click "Select" to continue.

Wireless Site Survey WLAN Function: Auto ▾

SSID	BSSID	Channel	Type	Encrypt	Signal	Select
AlexLien	00:0e:2e:64:7b:12	1	Infrastructure	Open	70%	<input type="radio"/>

Below the table are three buttons: "Refresh", "Next Page", and "Submit". The browser status bar at the bottom shows "Done" and "Internet".

You can use this “Site Survey” function to search for available access points in your location. In the list is the information of all available access points or wireless stations, includes SSID, BSSID, Channel, Type, Encryption and Signal Strength. You can select one wireless device in the list for this print server to associate with or you have to use General Setting to manually setup the wireless parameters.

Select: click the radio button in the “Select” column, and then click “Submit”. The print server will be connected to the wireless device you have selected.

Refresh: click “Refresh” to update the list.

Next Page: go to next web page.

Submit: Click “Submit” to confirm the connection with the wireless device.

There is also a “WLAN Function” setting for you to setup Auto/Disable/Enable wireless function of the print server here. Please refer to section 8.4.2.1 to know more about the setting.

8.4.3 TCP/IP

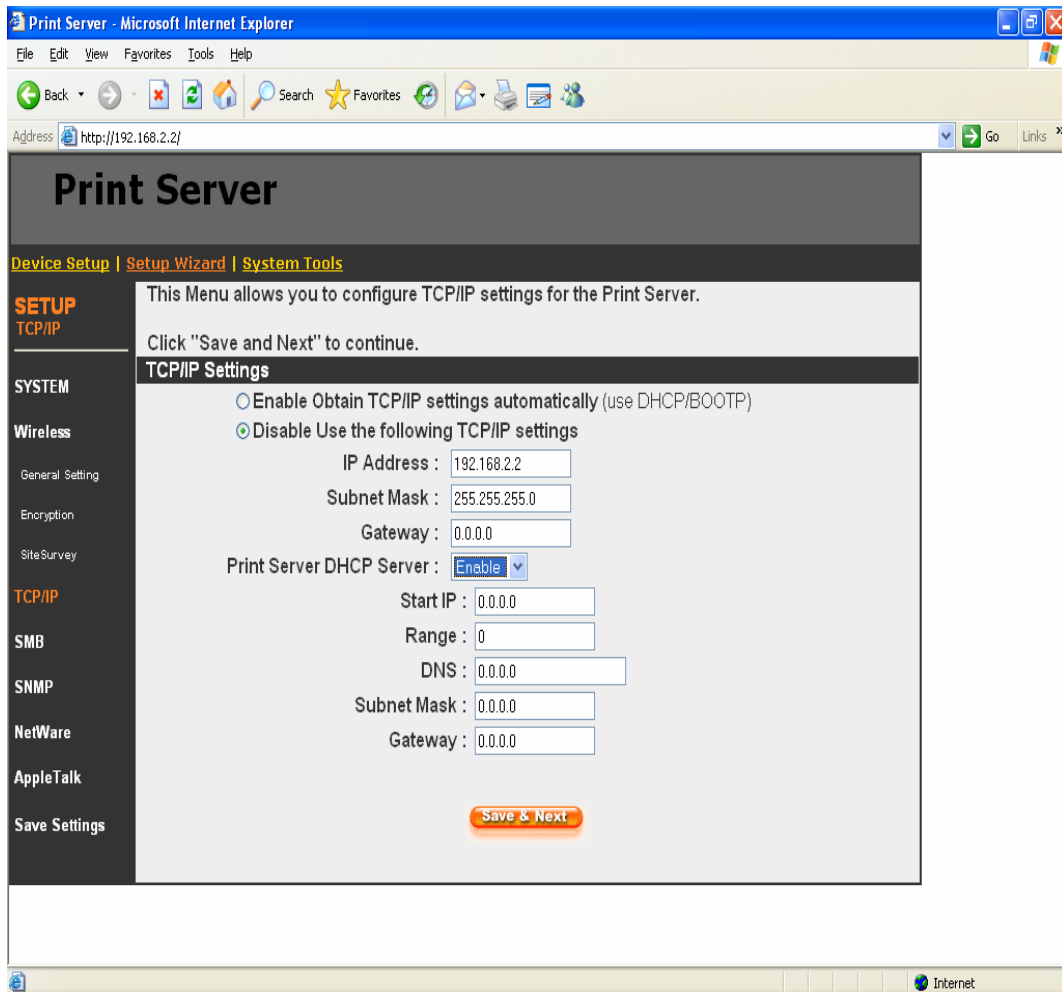

You can configure the print server to automatically get IP from DHCP server or manually specify static IP. The print server also has a built-in DHCP server. You can enable this DHCP server and let it manages IP for you.

If you need the print server to automatically get an IP from DHCP server, select “Enable Obtain TCP/IP Settings Automatically (Use DHCP/ BOOTP)”. You also can select “Disable Use the following TCP/IP Settings” to manually assign “IP Address”, “Subnet Mask” and “Gateway” for the print server.

You can enable/disable or set auto for the print server's DHCP server. The DHCP server is disabled by default. If the DHCP Server is enabled or set Auto, you have to assign a range of IP addresses here. Fill in the "Start IP", "Range", "DNS", "Subnet Mask" and "Gateway", and the print server will assign a unique IP for each client. Note that when "Auto" is selected, the DHCP Server of the print server will be enabled only when there is no other DHCP Server within the network.

8.4.4 SMB

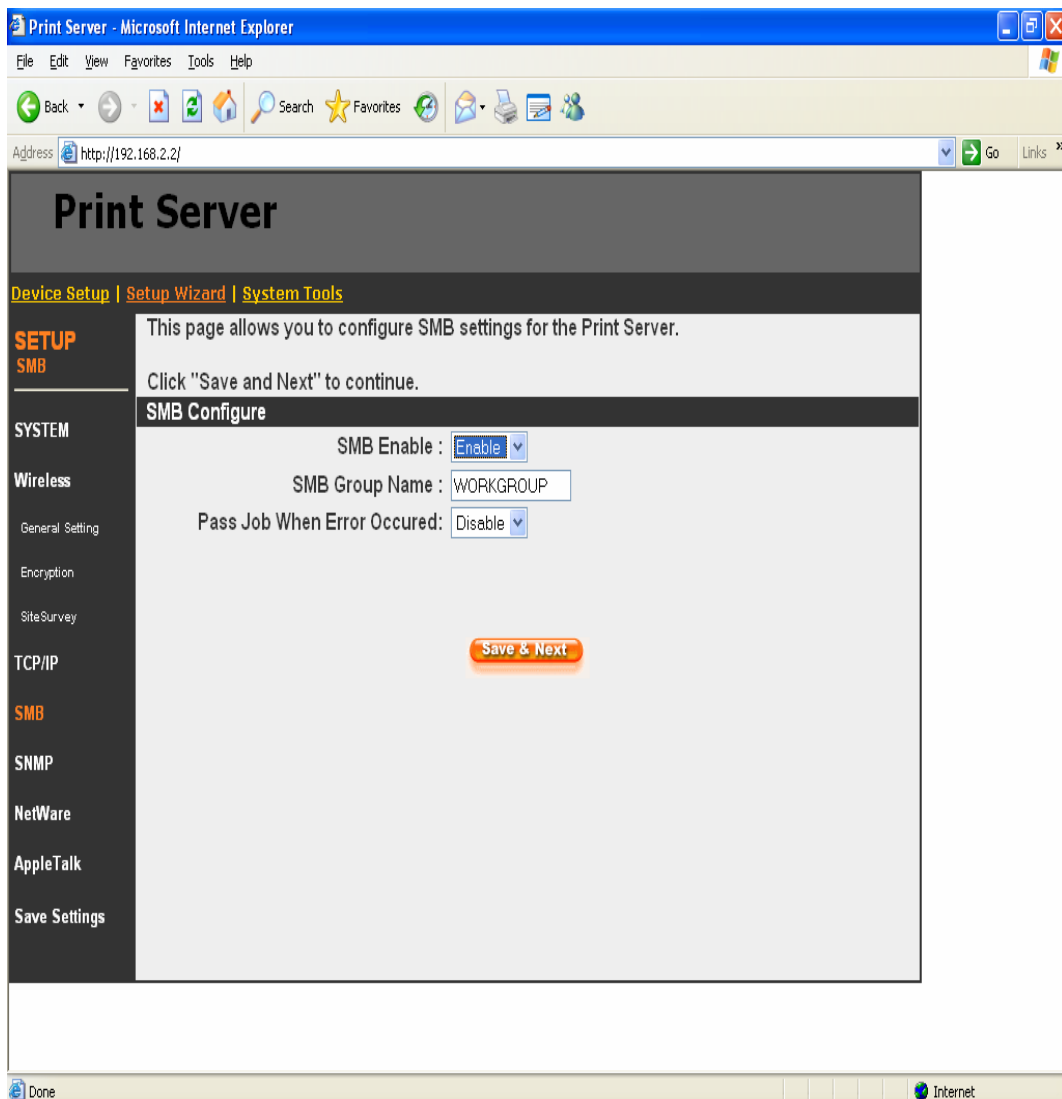

You can enable/disable the SMB protocol from here. If SMB is enabled, enter the “SMB Group Name” to specify the SMB group that this print server belongs to. All PC should join the same group before they can use this print server by SMB protocol.

“Pass Job When Error Occurred” is for you to set the interval time for bypassing the current printing job in order to avoid the printing job is not printed completely while the printer is interrupted unexpectedly because of paper out or off line.

8.4.5 SNMP

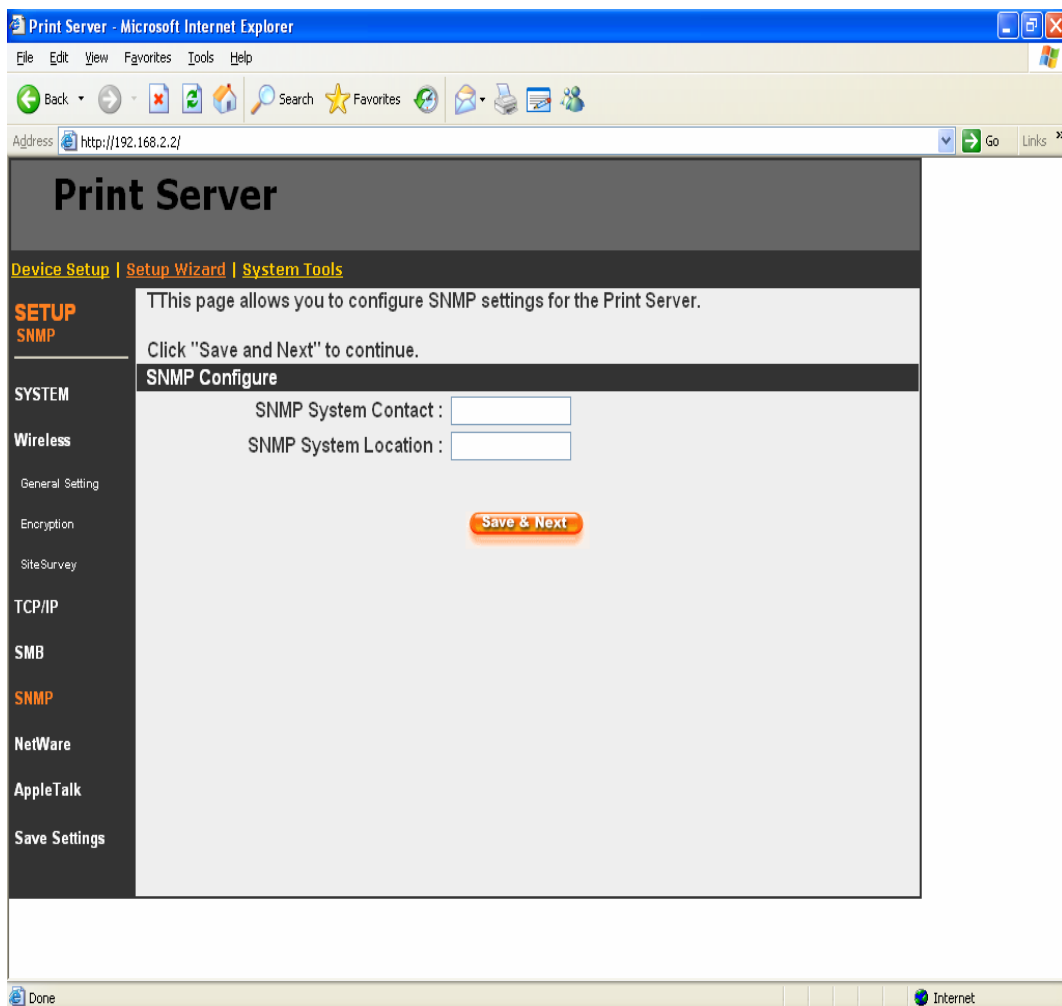

The print server supports SNMP configuration. If it is enabled, please set up the following parameters.

SNMP System Contact: You can enter the print server administrator's contact information here. This information will be displayed in the SNMP management tool.

SNMP System Location: You can enter the installed location of the print server here. This information will be displayed in the SNMP management tool.

8.4.6 NetWare

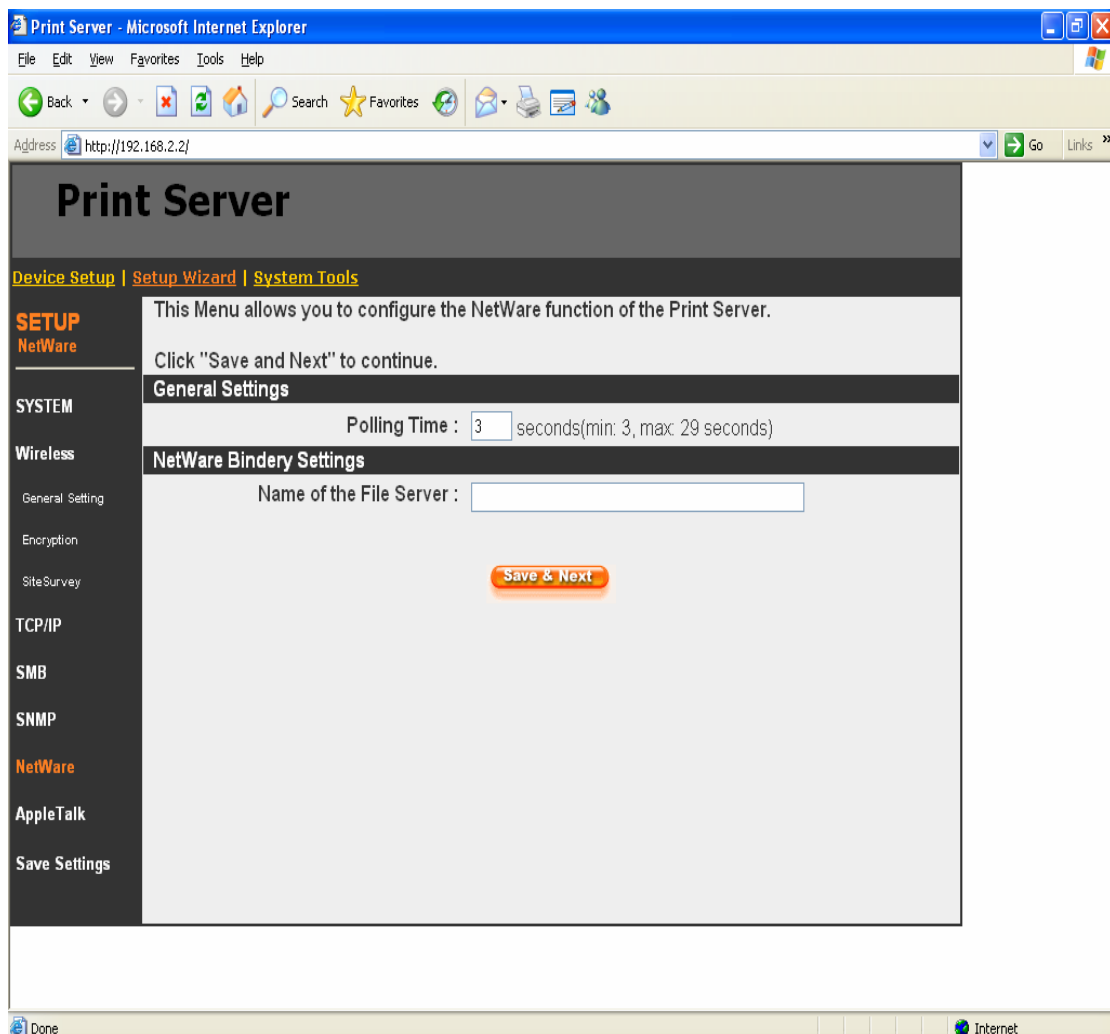

This print server supports NetWare Bindery Printing method. The print server periodically polls the NetWare server printer queues for printing jobs. You have to assign the NetWare server name, print server polling interval and the name of queue on the NetWare server for each printer port.

Polling Time is the polling interval of the print server for waiting printing jobs on the NetWare server.

Name of the File Server is the name of the NetWare file server that provides printer queues.

8.4.7 AppleTalk

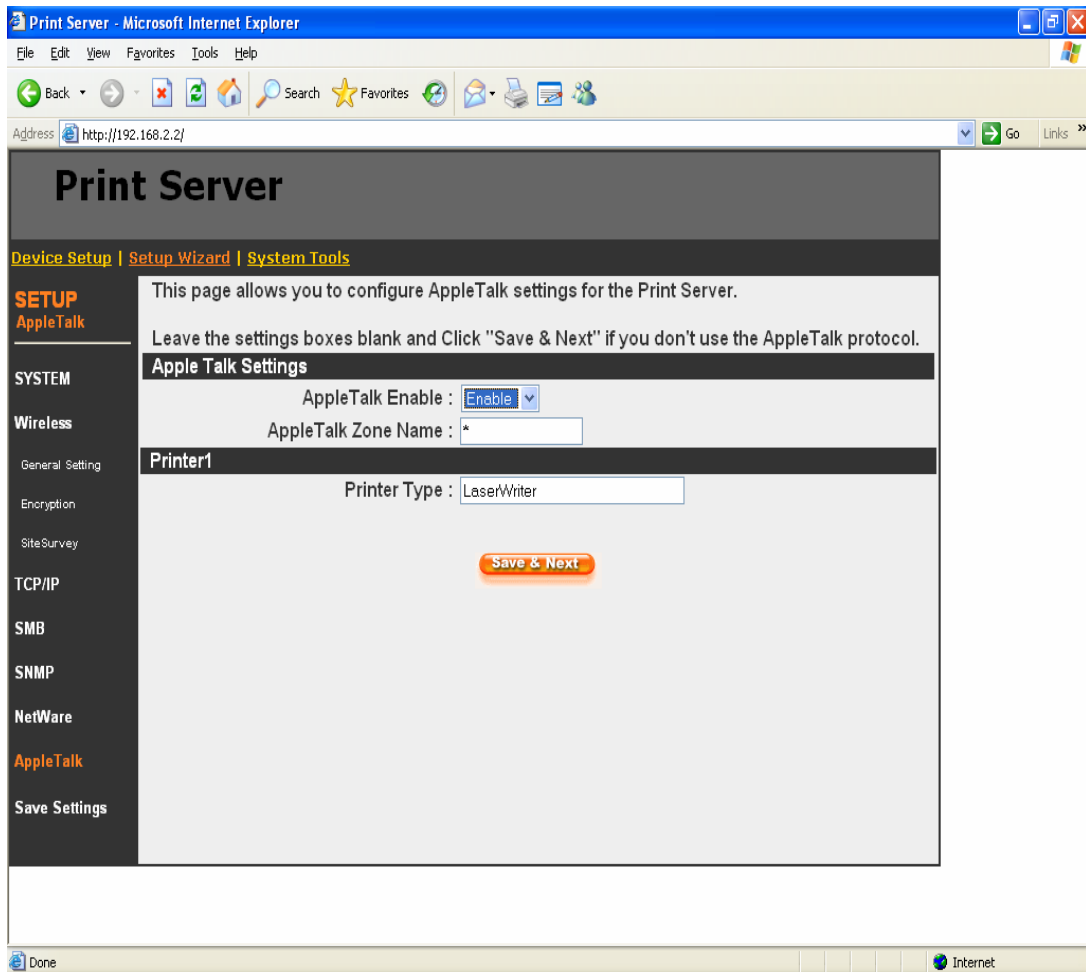

AppleTalk is a data communication protocol often used by Macintoshes. The print server can use these parameters to join the AppleTalk network and share the printer to other AppleTalk workstations. You have to select to enable or disable AppleTalk, and setup the “Zone Name” and “Printer Type” for each printer port of this print server.

AppleTalk Enable: Enable or disable “AppleTalk”.

AppleTalk Zone Name: Print server has to join zones of AppleTalk before it can be shared to other workstations. Only workstations in the same zone can share the printer. If you want to share the printer to all workstations in all Zones, you should enter only “*” in the “Zone Name” field.

Printer Type, the type of printer attached to each printer port. You can get the printer type from the manufacturer of the printer.

8.4.8 Save Settings

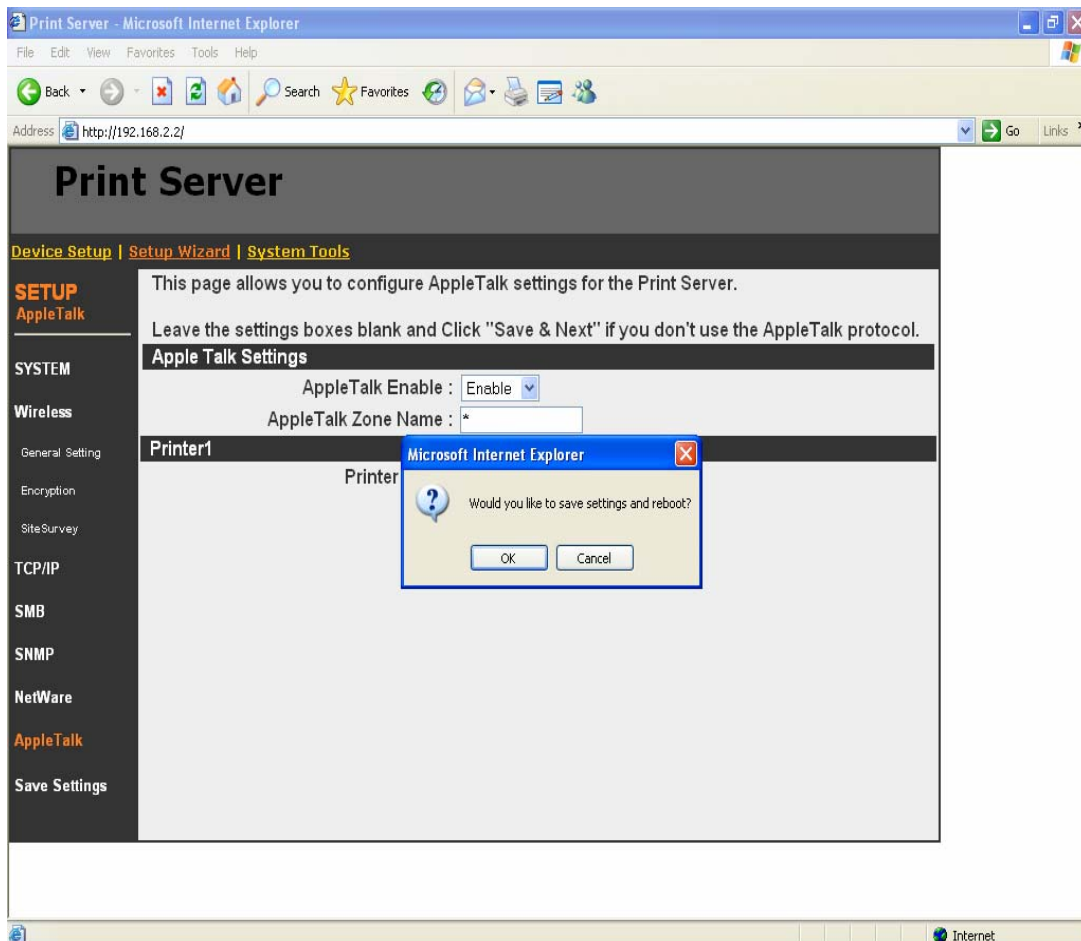

You can click the “Save Settings” to save the settings and restart the system.

8.5 System Tools

8.5.1 Load Default



You can use this page to restore the factory default settings. All of your previous setup will be cleared.

8.5.2 Upgrade Firmware from Browser

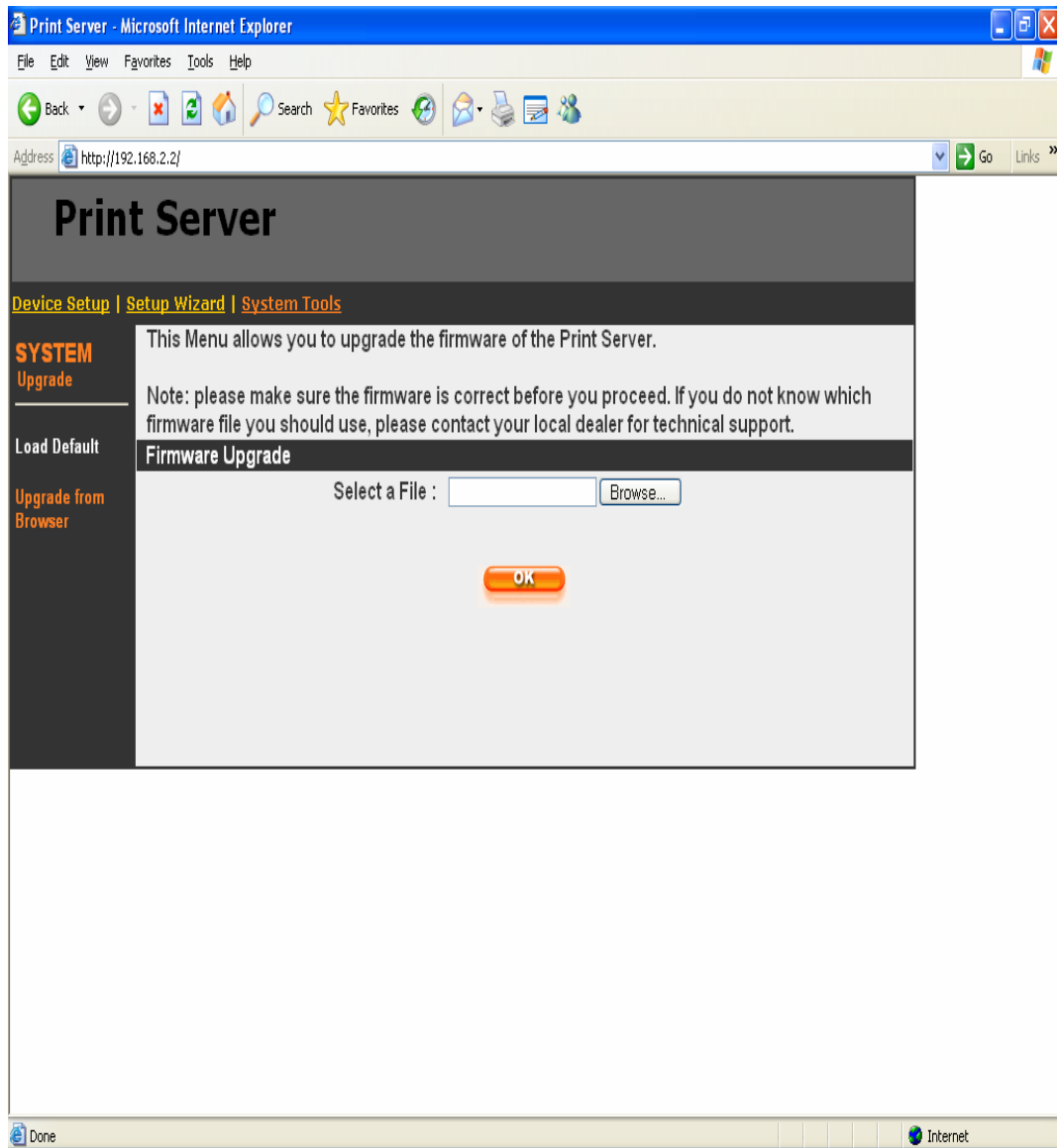

You can upgrade new firmware for this print server in this page. Click “Browse” to select the new firmware in your storage and then click “OK”, the firmware will be updated in several minutes.

Be aware that if you have started upgrading firmware, you have to follow all the upgrading steps or the print server can't turn back to normal configuration.

9. IPP Printing

9.1 Introduction

IPP (Internet Printing Protocol) Printing provides a convenient way of remote printing service by TCP/IP. The print server can support IPP printing by default. It is needless to do any setting. Any PC that can support IPP printing, for example Windows 2000/XP, can directly uses the print server by IP. By using the IPP printing, you can share the printer to all the PC's that can access the print server by IP. You can even share your printer to Internet users.

9.2 System Setup

9.2.1 Print Server Side

It is needless to do any setting on the print server side. Make sure the print server has correct IP settings. If you want to share the printers to Internet users, you have to set a real IP to the print server. You also have to make sure that any gateway, router or firewall does not block IPP protocol if you have these gateway devices installed in your network.

9.2.2 Client Side

You only need to perform Window's standard **Add New Printer** procedure.

Step1. Click "Start", choose "Settings" and select "Printers and Faxes".

Step2. Click "Add a Printer".

Step3. The "Add Printer Wizard" is displayed. Click "Next".

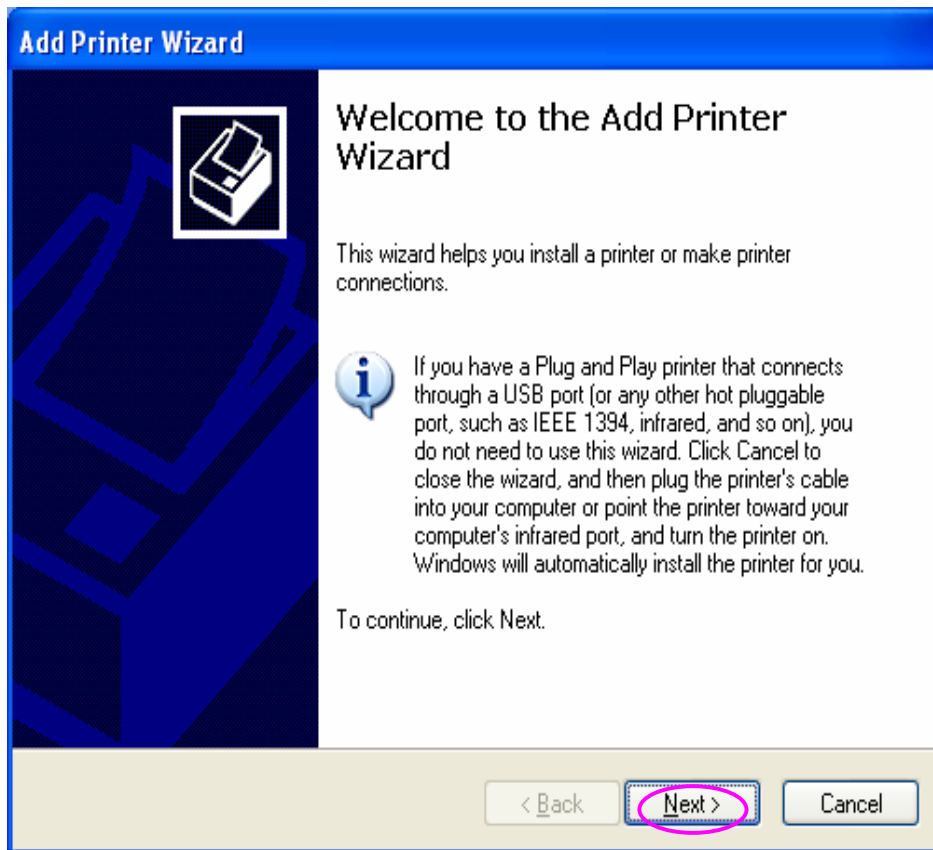

Step4. Select “A network printer, or a printer attached to another computer”. Click “Next”.

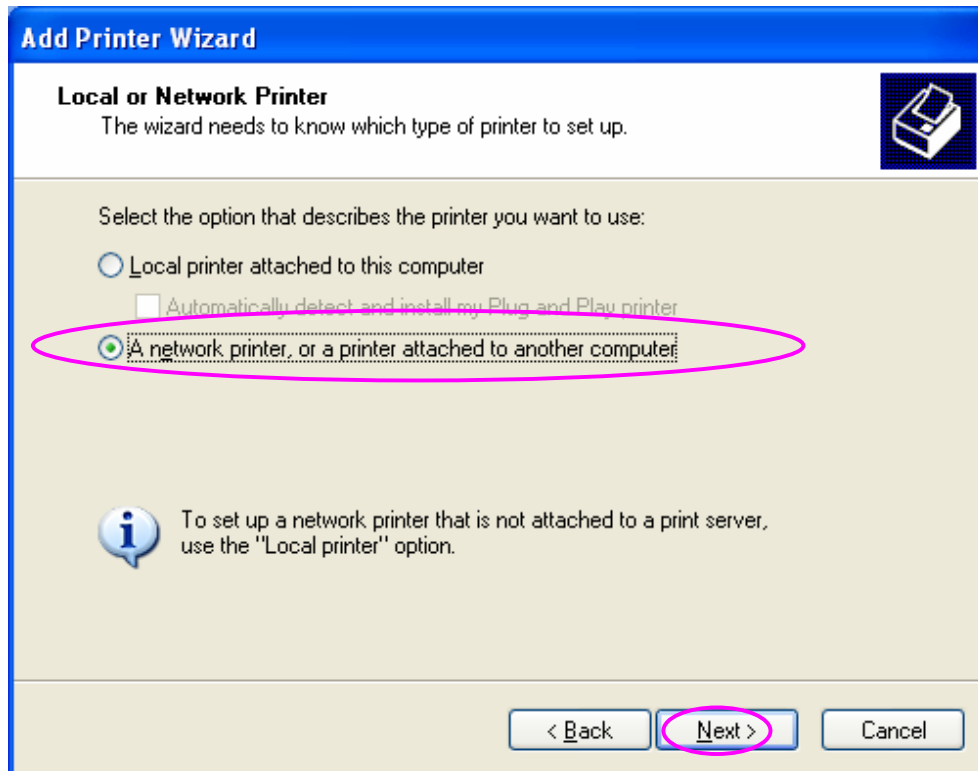

Step5. Select “Connect to a printer on the Internet or on a home or office network” and enter the URL of print server. The URL format is “http://IP:631/Port Name”. The IP should be the print server’s IP. The number 631 is IPP standard port number. Port Name is the port name of print server that your printer is connected to. The default port name is “lpt1”. One example of the URL is http://192.168.3.66:631/lpt1. After entering the URL of print server, click “Next”.

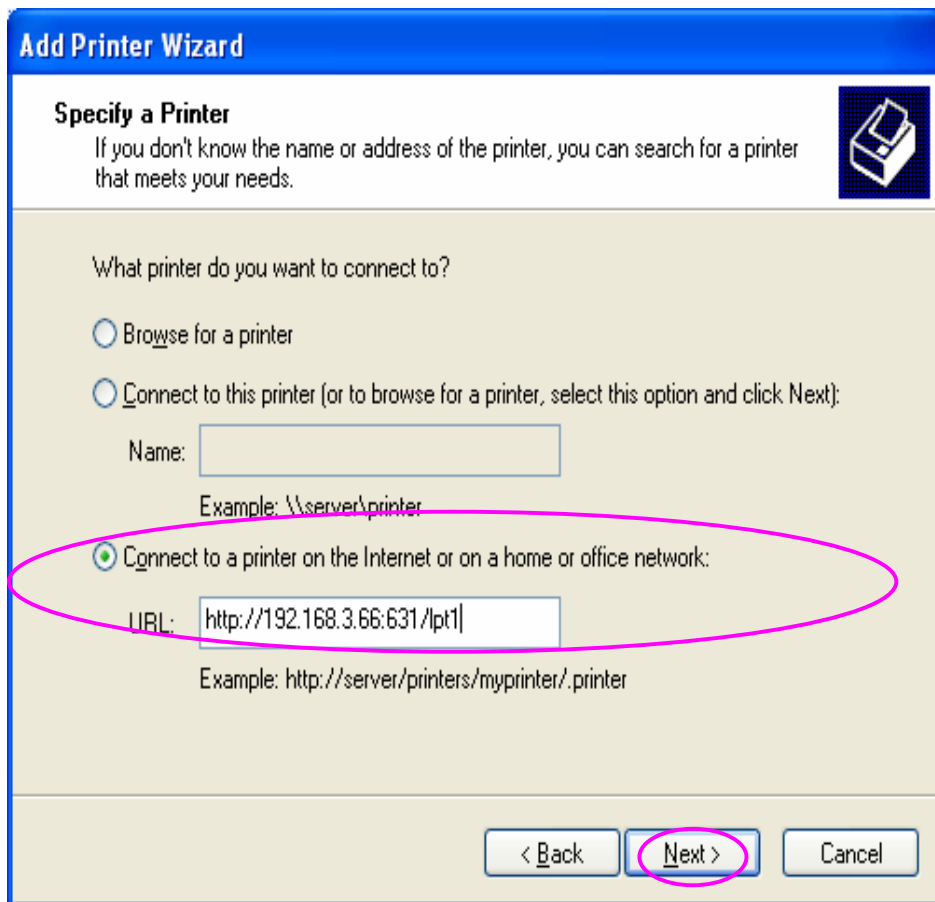

Step6. Select a suitable printer manufacturer and the printer model and click “Next”. If your printer is not in the list, click “Have Disk...” to install the driver of the printer. After installation, the printer model will be added to the list.

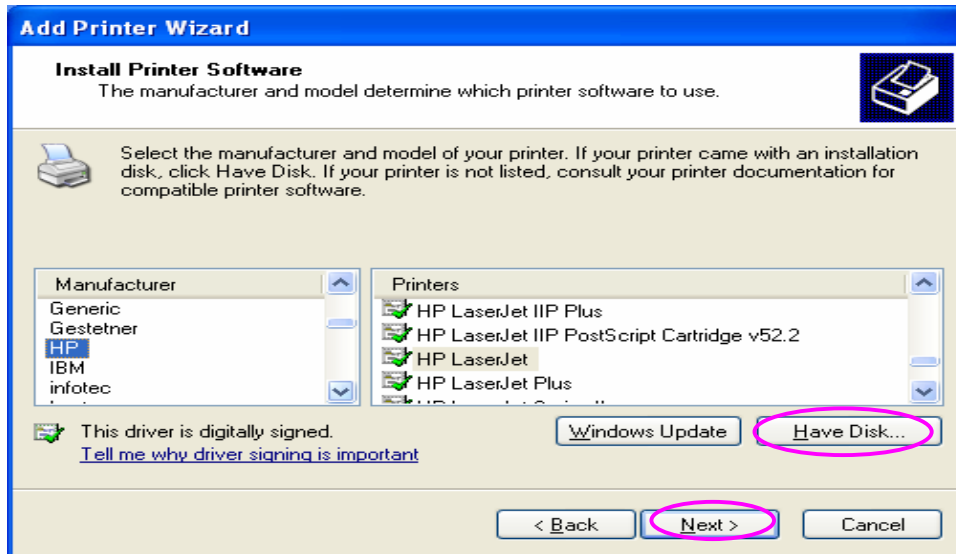

Step7. Choose to set the print whether as a default printer or not. Click “Next”.

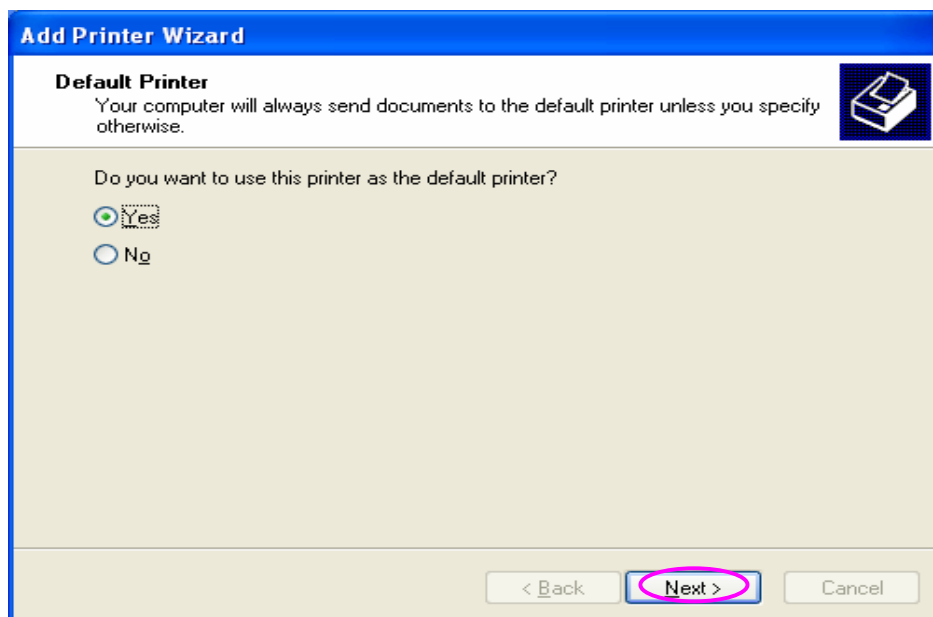

Step8. You have added the network printer to the PC successfully. The information of the printer is displayed in the windows. Click “Finish”.

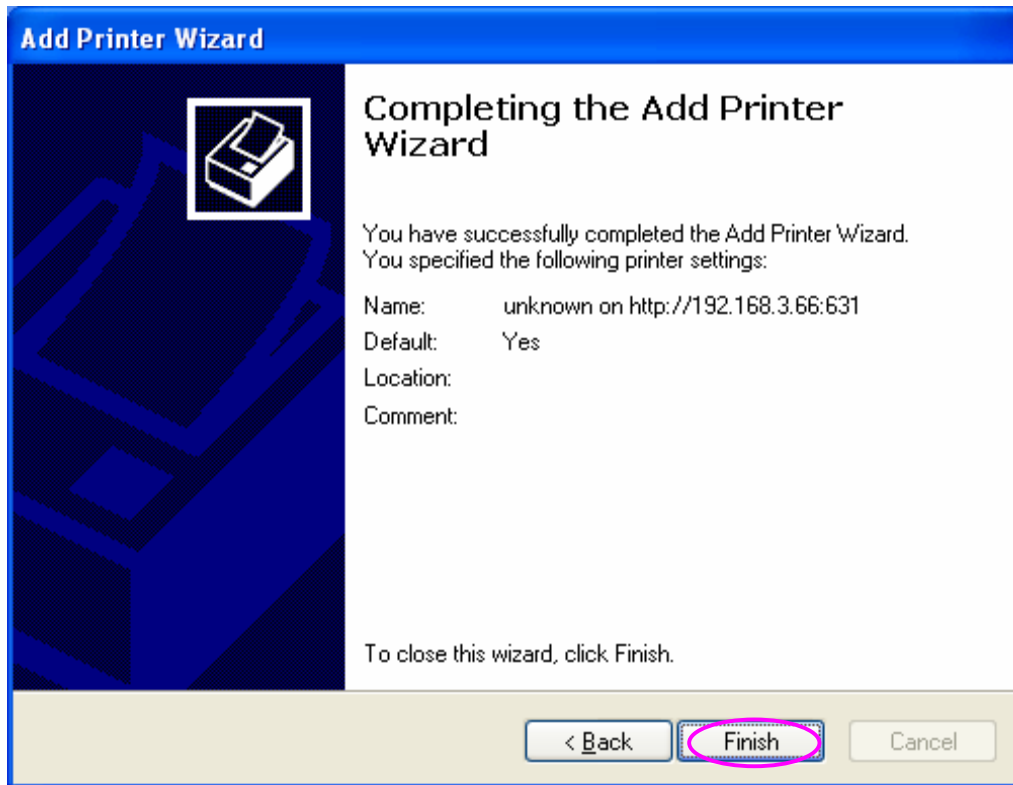

10. LPR Printing

10.1 Introduction

LPR Printing (Line Printer Remote technology) allows users to connect to printers via TCP/IP for printing sharing. The computer with Windows 98SE/Me/NT/2000/XP/2003, Windows Vista and MAC OS 10.x Operating Systems can use the protocol to share printing in the network. Print Server can support LPR printing by default.

If you install the Print Server in Windows 98SE/Me/NT, the Print Server provides a tool “Network Ports Quick Setup” that helps to add the LPR protocol to users’ computer easily. Please refer to Section 3.5.1.

To configure the LPR setting in Windows 2000/XP/Vista and MAC OS 10.x, please follow the procedures describe in the following sections.

10.2 Standard LPR Settings in Windows XP

To configure the LPR setting in Windows XP, please follow the steps below. The LPR setup procedures in Windows 2000 and 2003 are similar.

1. Click “Start”, choose “Settings” and select “Printers and Faxes”.
2. Click “Add a Printer”.
3. The “Add Printer Wizard” is displayed. Click “Next”.

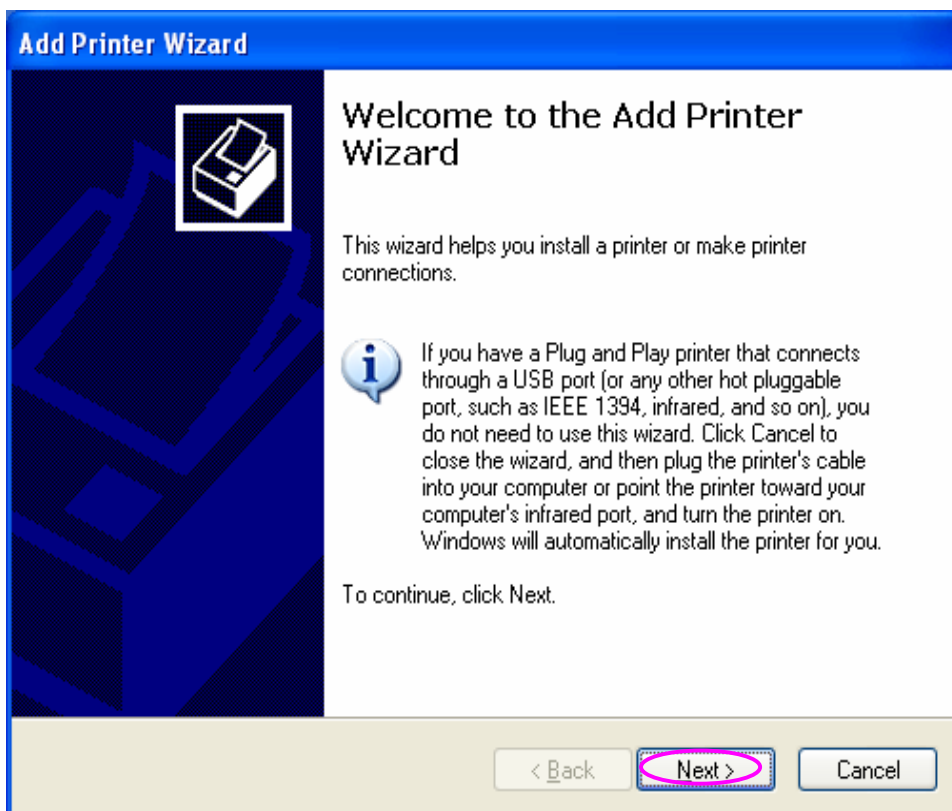

4. Select “Local Printer attached to this computer” and click “Next”.

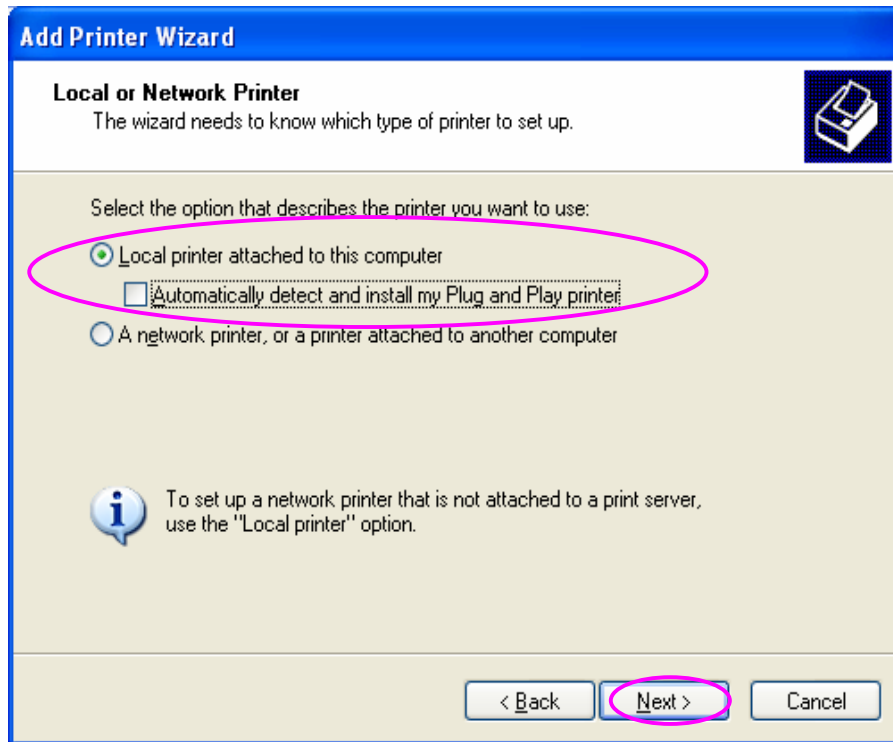

5. Choose “Create a new port” and “Standard TCP/IP Port”. Click “Next”.

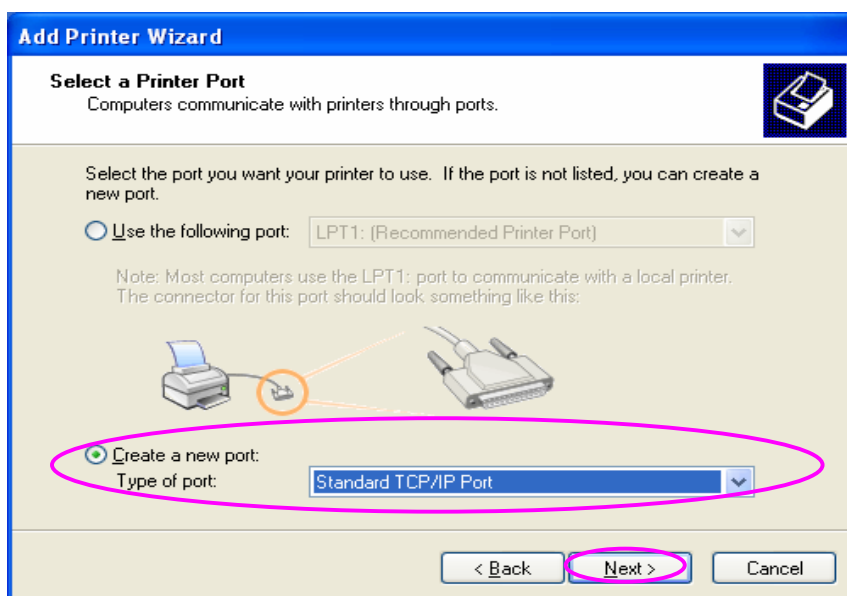

6. Please make sure that the Print Server and the Printer have turned on and connected to the network correctly before you continue. Click “Next”.



7. Enter the IP Address of the Print Server in the “Printer Name or IP Address”. Click “Next”.

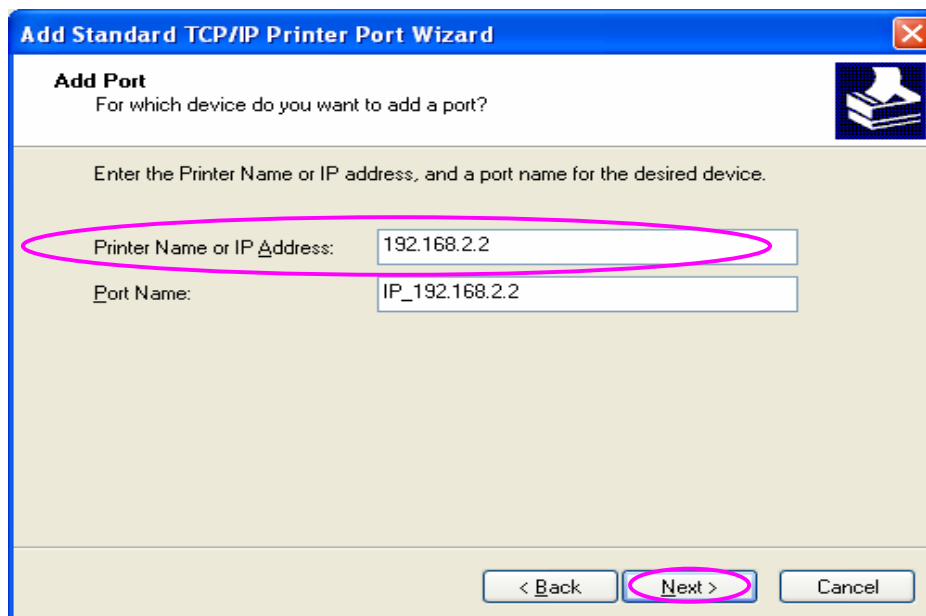

8. Select “Custom” and click “Settings”. When you have finished the settings at step 9, click “Next” to continue.

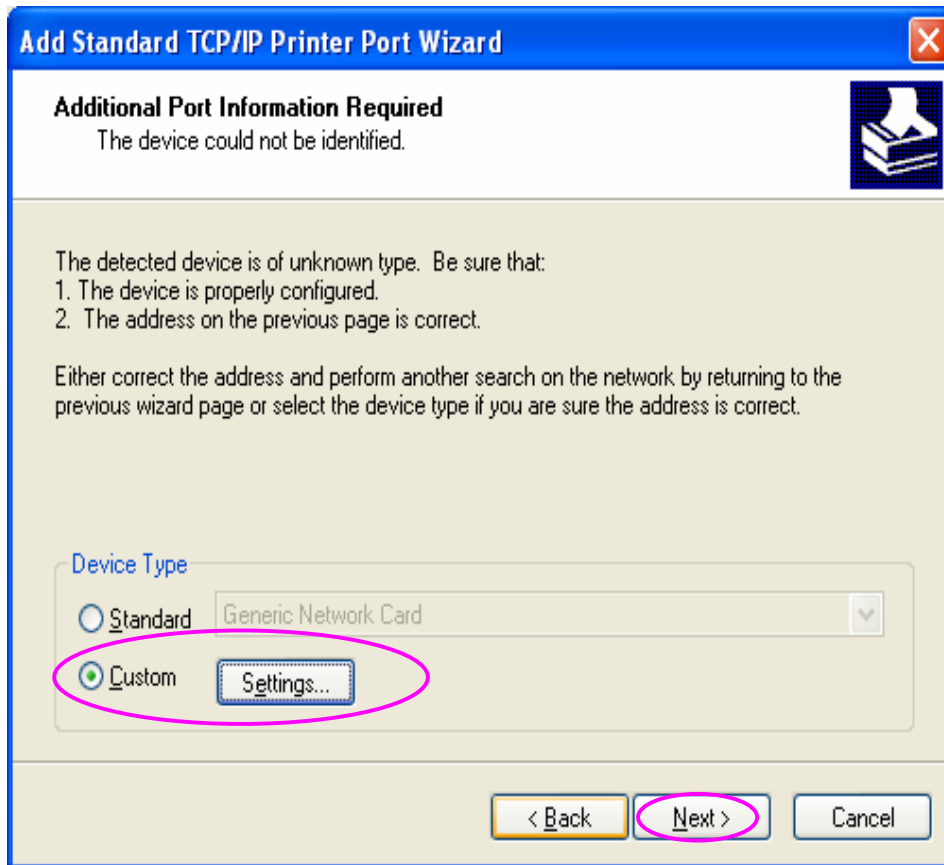

9. Select “LPR” and enter “lpt1” in the “Queue Name”, click “OK”. By default the queue name of the Print Server is “lpt1”.

Configure Standard TCP/IP Port Monitor

Port Settings

Port Name: IP_192.168.2.2

Printer Name or IP Address: 192.168.2.2

Protocol

Raw LPR

Raw Settings

Port Number: 9100

LPR Settings

Queue Name: lpt1

LPR Byte Counting Enabled

SNMP Status Enabled

Community Name: public

SNMP Device Index: 1

OK Cancel

10. Click “Finish”.

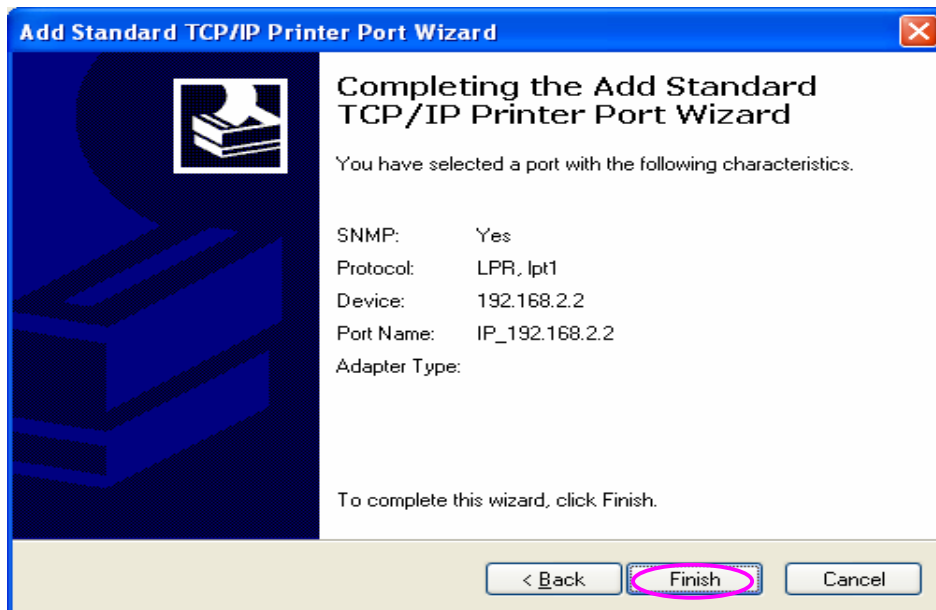

11. Select a suitable printer manufacturer and the printer model and click “Next”. If your printer is not in the list, click “Have Disk...” to install the driver of the printer. After installation, the printer model will be added to the list.

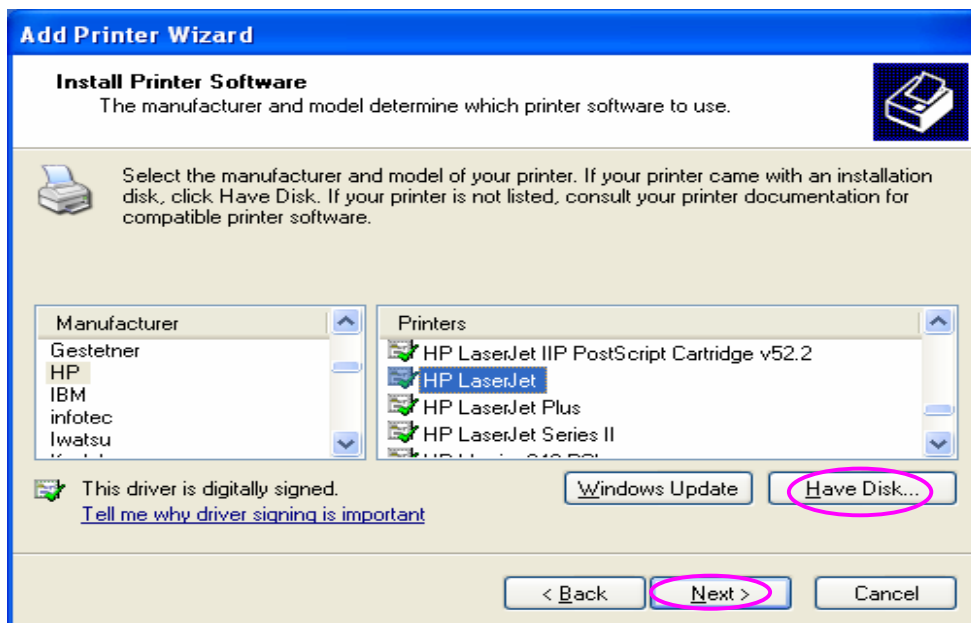

12. Choose to set the print whether as a default printer or not. Click “Next”.

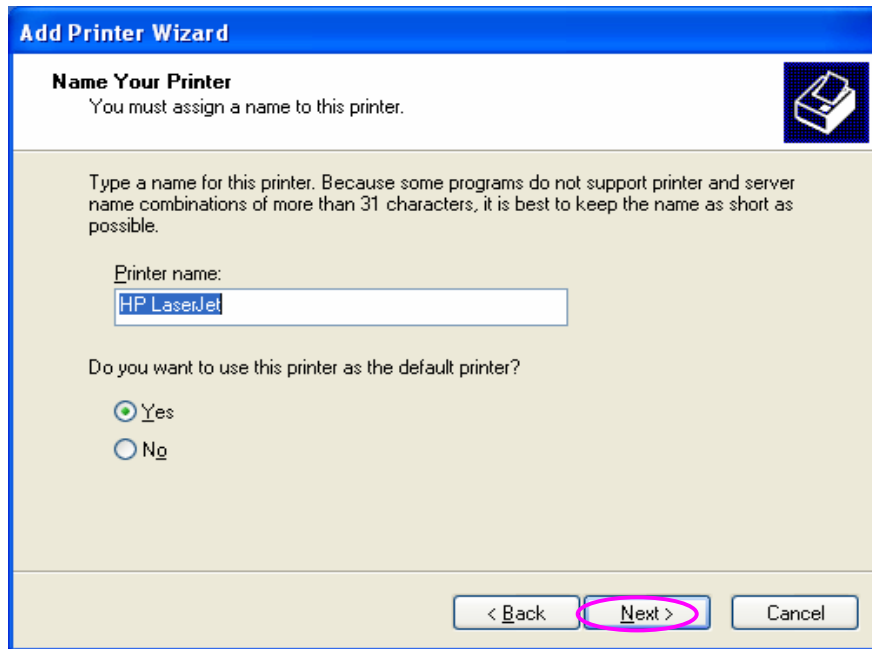

13. You have added the network printer to the PC successfully. The information of the printer is displayed in the windows. Click “Finish”.

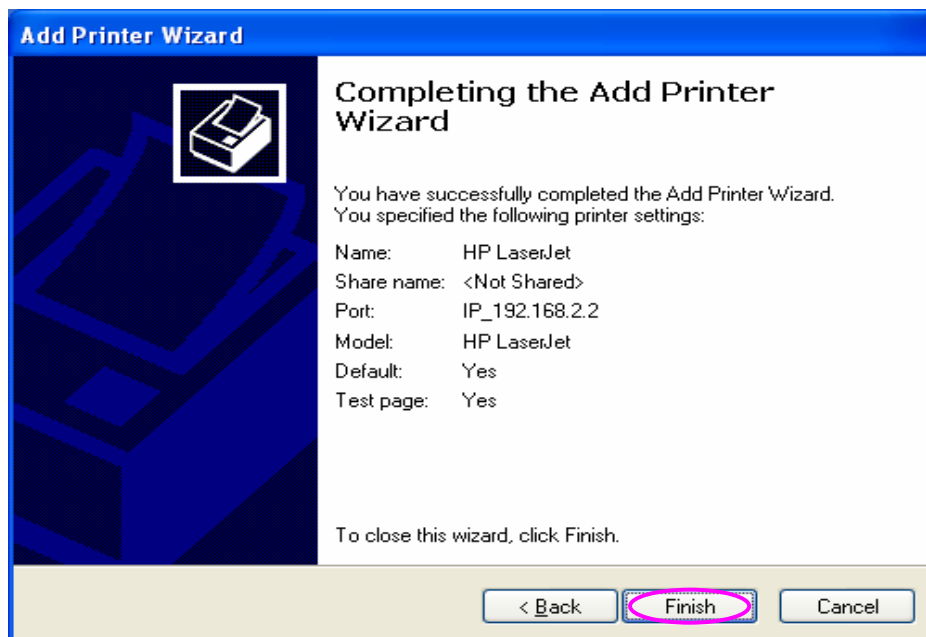

10.3 Standard LPR Settings in Windows Vista

To configure the LPR setting in Windows Vista, please follow the steps below.

1. Click “Start”, select “Settings\Printers”.
2. Click “Add a Printer”.
3. The “Add Printer” wizard is displayed. Select “Add a local printer”.

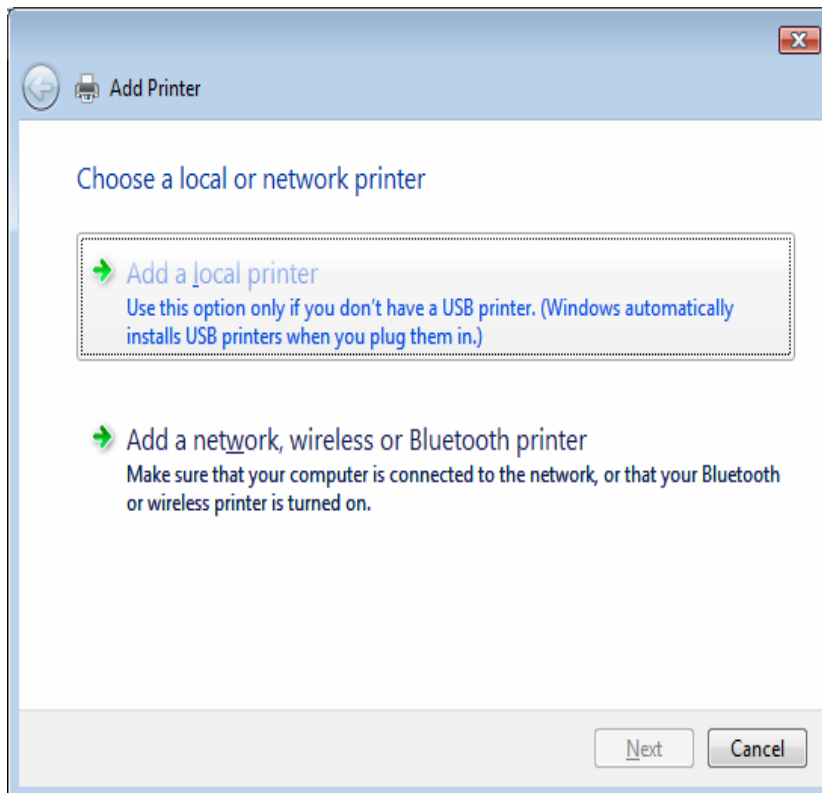

4. Choose “Create a new port” and select “Standard TCP/IP Port”. Click “Next”.

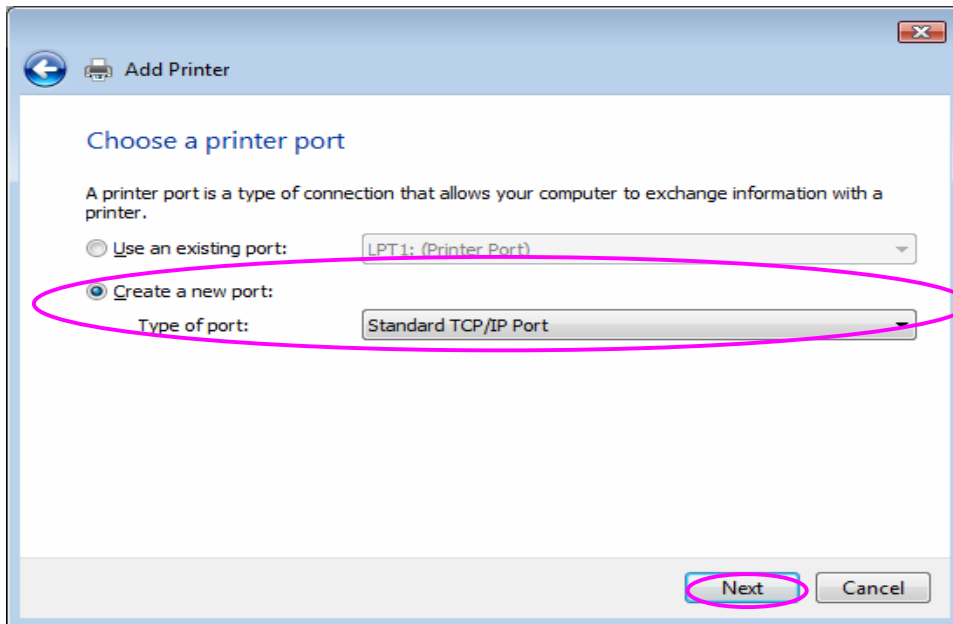

5. Enter the IP Address of the Print Server in the “Hostname or IP address” field. Click “Next”.

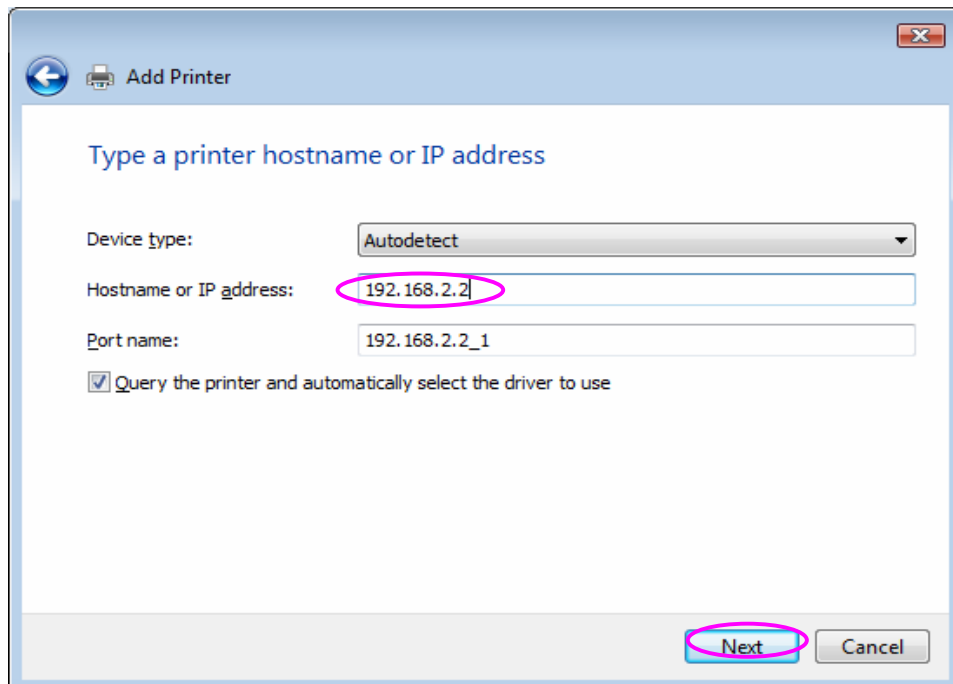

6. Select “Custom” and click “Settings”. When you have finished the settings at step 7, click “Next” to continue.

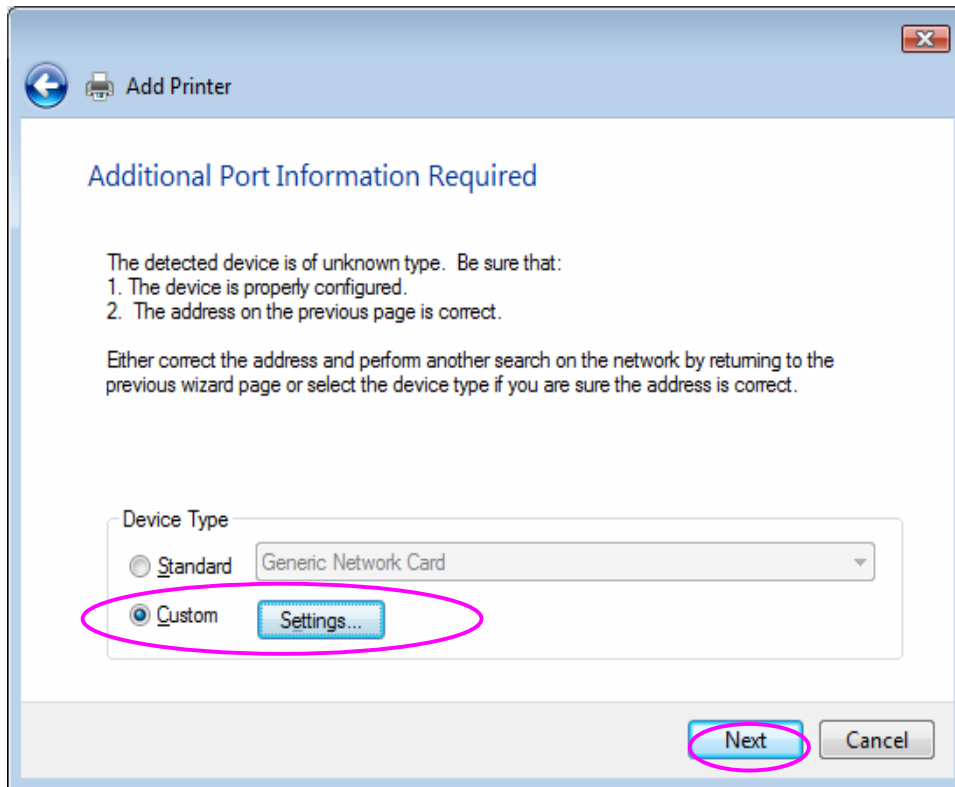

7. Select “LPR” and enter “lpt1” in the “Queue Name”, click “OK”. By default the queue name of the Print Server is “lpt1”.

Configure Standard TCP/IP Port Monitor

Port Settings

Port Name: 192.168.2.2_1

Printer Name or IP Address: 192.168.2.2

Protocol

Raw LPR

Raw Settings

Port Number: 9100

LPR Settings

Queue Name: lpt

LPR Byte Counting Enabled

SNMP Status Enabled

Community Name: public

SNMP Device Index: 1

OK Cancel

8. Select the printer manufacturer and the printer model and click “Next”. If your printer is not in the list, click “Have Disk...” to install the driver of the printer. After installation, the printer model will be added to the list.

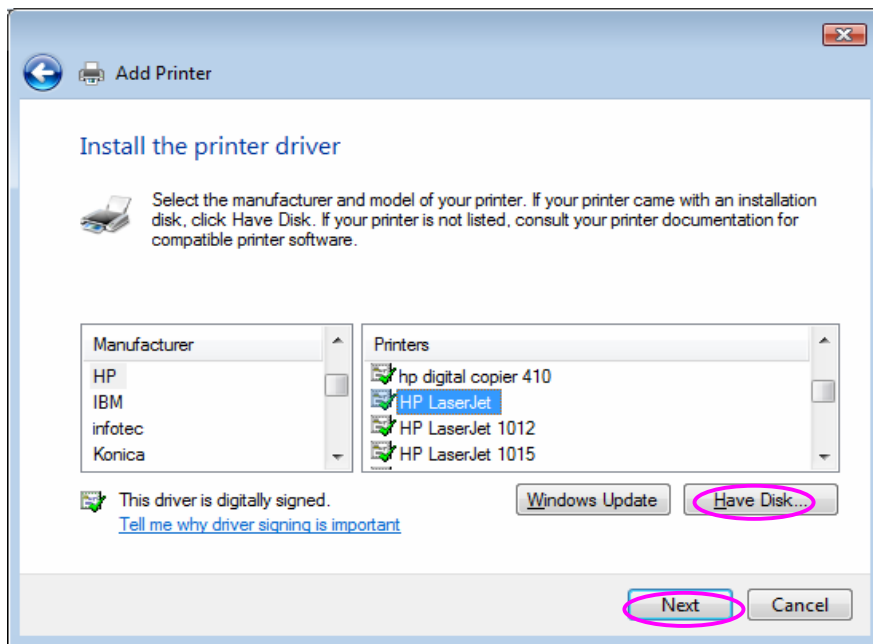

9. Name your printer and set the default printer, click “Next”.

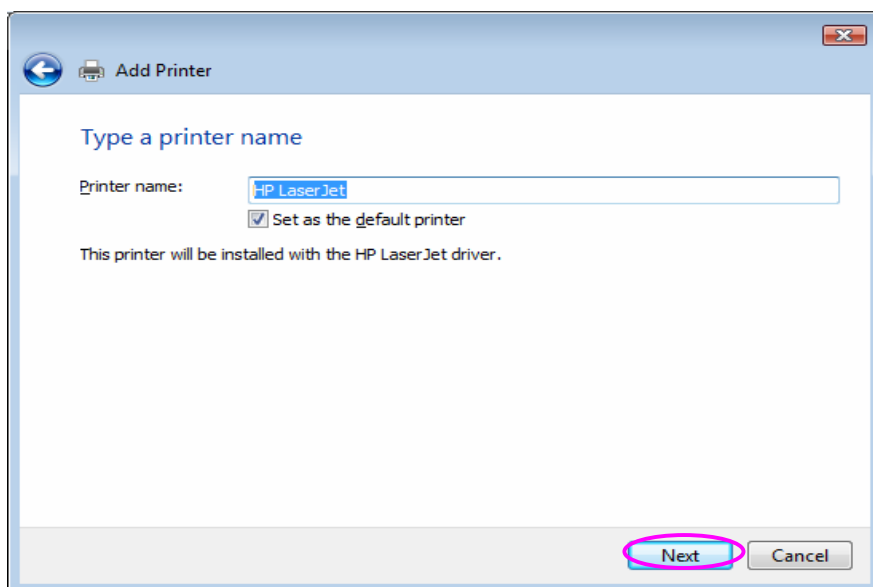

10. The printer drivers are being installed.

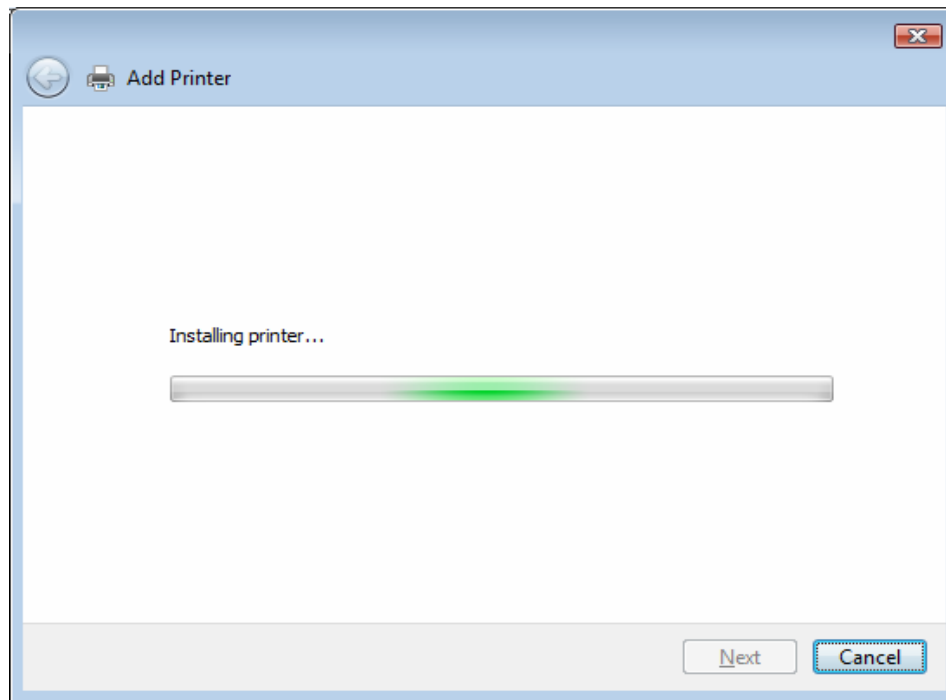

11. It is recommended to print a test page. Click "Finish".

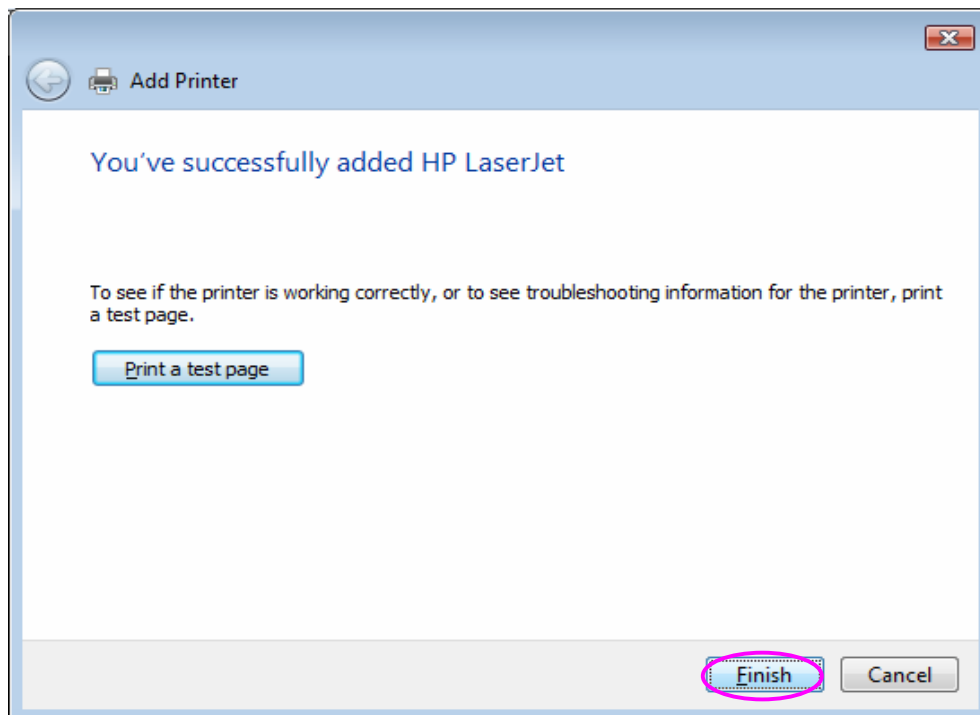

12. The printer is added to “Printers” page, you have added the printer to your computer successfully. Now you can start to print from your computer to the print server.

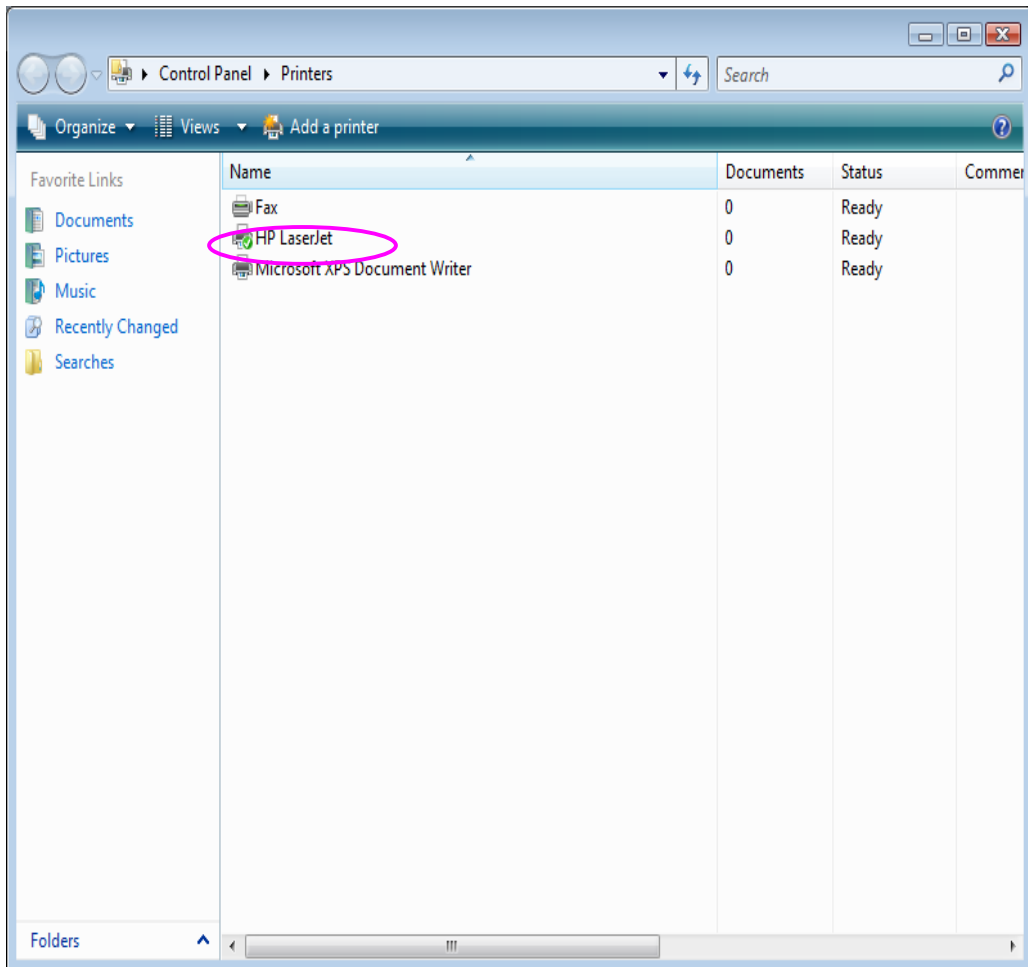

10.4 Standard LPR Settings in MAC OS 10.x

10.4.1 MAC 10.4.x

To enable LPR Printing in Macintosh 10.4.x, please follow the procedures below.

Open Print and Fax from the System Preferences.

With the Printing tab selected, click the “Add” button.

When the Printer Browser opens, select “IP Printer”.

In the “IP Printer” screen, please configure as below.

Protocol: Select Line Printer Daemon - LPD as the Protocol.

IP Address: Set the address to the Print Server’s IP Address, for example: 192.168.2.2.

Queue: Set the queue name to lpt1.

Name: You can designate a name for the printer.

Location: You can enter the location of the printer.

Printer: Select the printer model that is attached to the Print Server.

Click “Add” to complete the printer installation.

10.4.2 MAC 10.3.x

To enable LPR Printing in Macintosh 10.3.x, please follow the procedures below.

1. In the Desktop, click “System Preferences”.



2. Click “Print & Fax”.



3. From the “Print & Fax” screen, click “Set Up Printers...”.

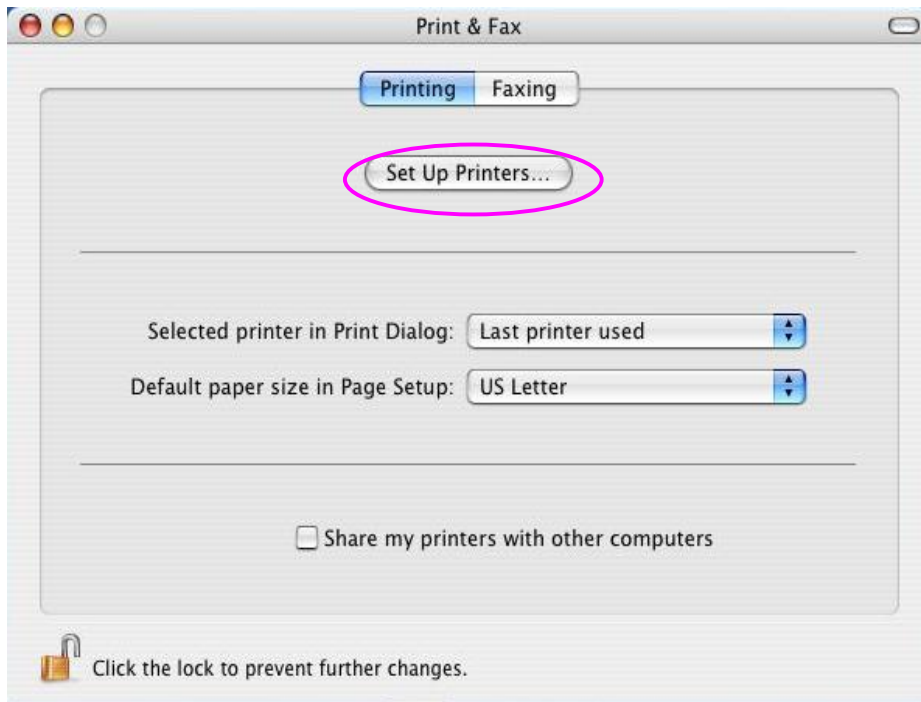

4. Click “Add” to add the new Print Server through TCP/IP.

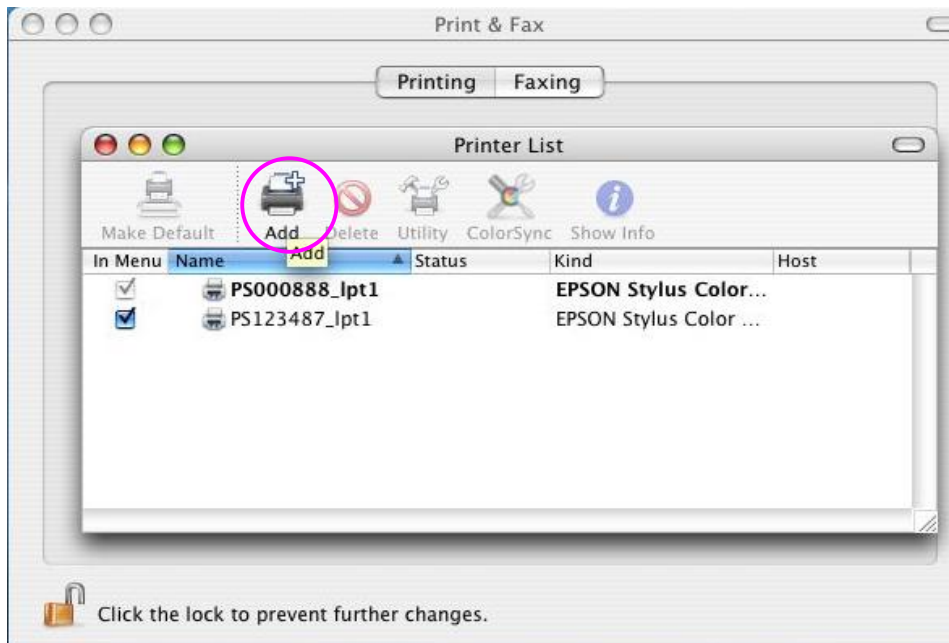

5. Enter the “Printer Type”, “Printer Address” and “Queue Name” and select the “Printer Model” to setup the Print Server. Click “Add” to continue.

Printer Type: LPD/LPR

Printer Address: Input the IP Address of the Print Server

Queue Name: The queue name of the Print Server is “lpt1”.

Printer Model: Select the Printer Model that is attached to the Print Server.

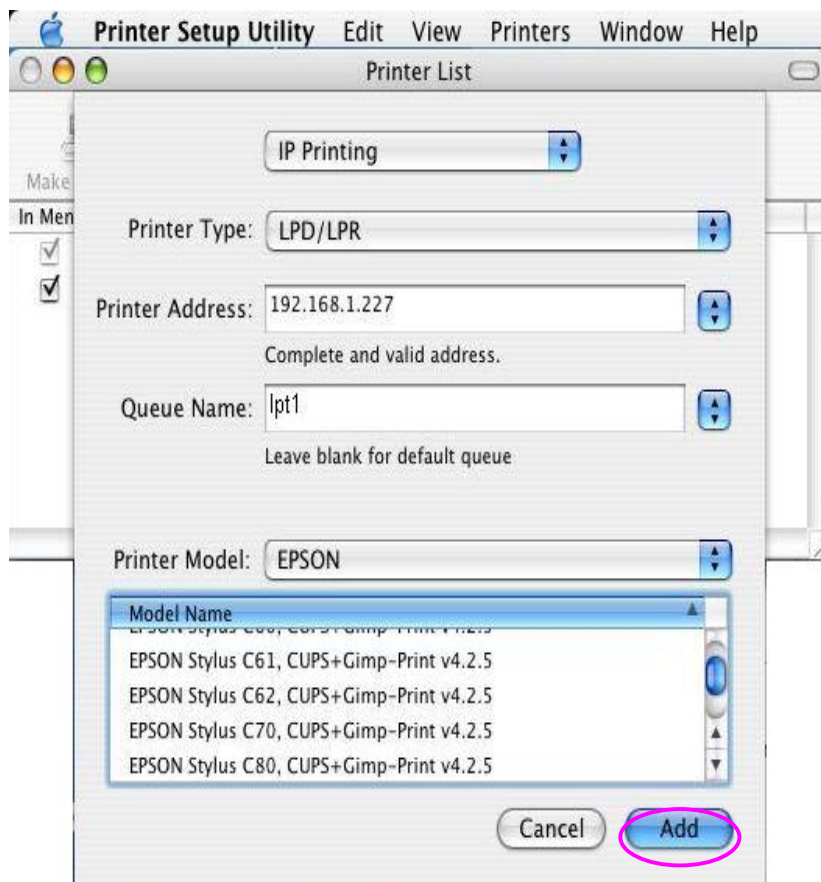

6. The Print Server is installed completely. You can see it in the “Printer List”.

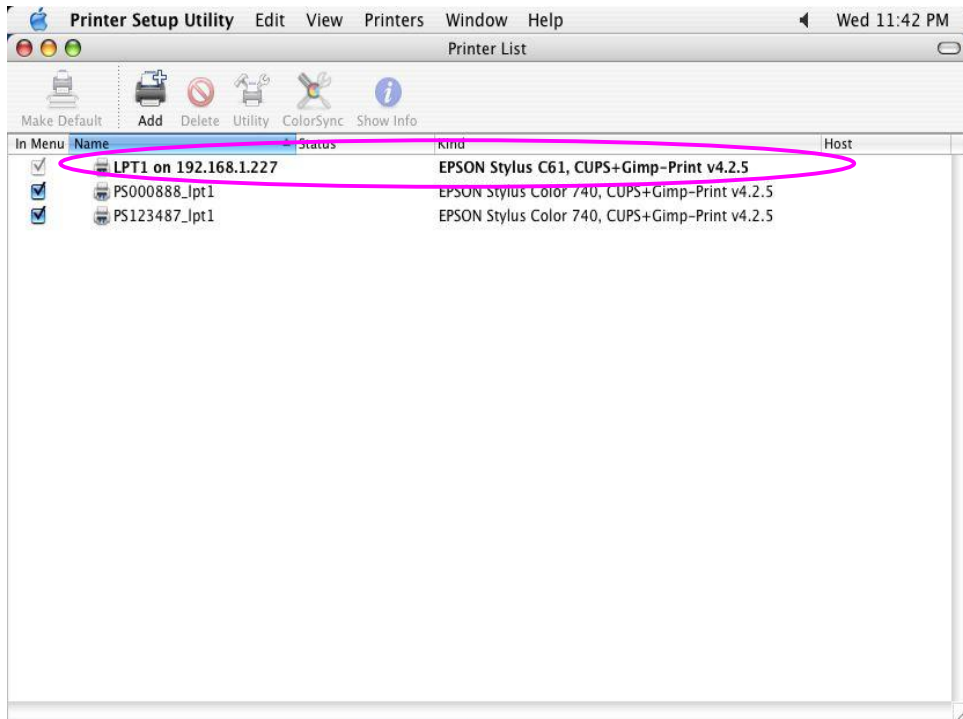

7. You can print a file to check whether the Print Server is installed successfully.

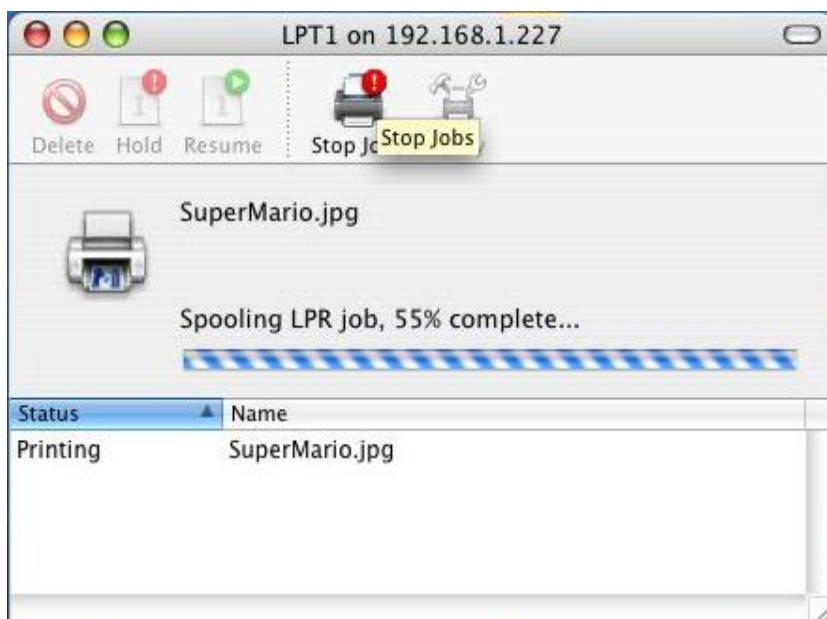

11. Windows XP SP2 Setup

In Windows XP SP2, XP SP2's firewall would block the unknown communications. This print server has allowed the communications data passed through the XP SP2's firewall.

In case that you do not find any print server listed on the "Available Ports" in "Network Ports Quick Setup", please follow the steps below.

Step1. Click "Start", choose "Settings" and select "Network Connections".

Step2. Right click "Local Area Connection" and select "Properties".

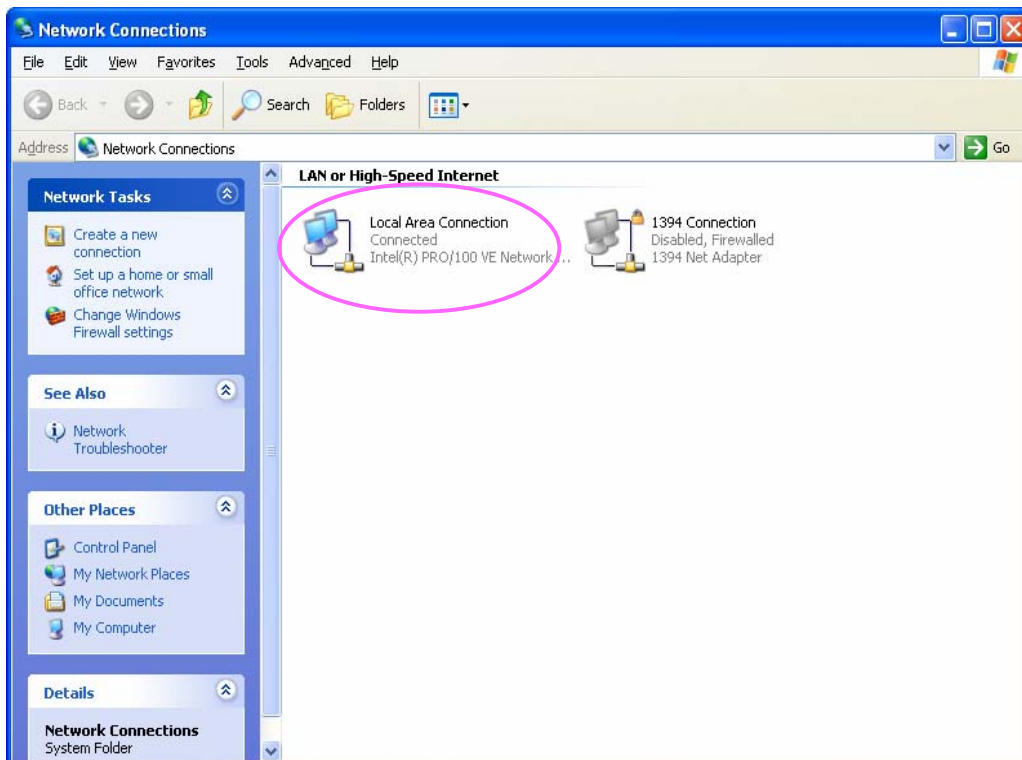

Step3. Select “Advanced” tab and click “Settings...”.

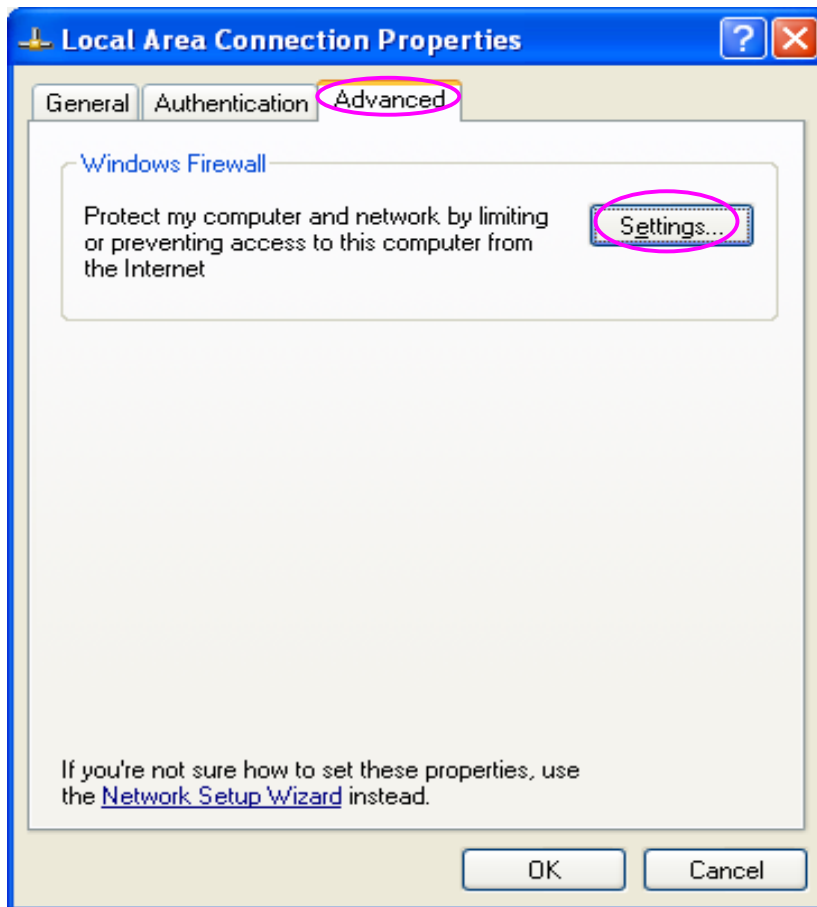

Step4. Select “Exceptions” tab and click “Add Program...”.

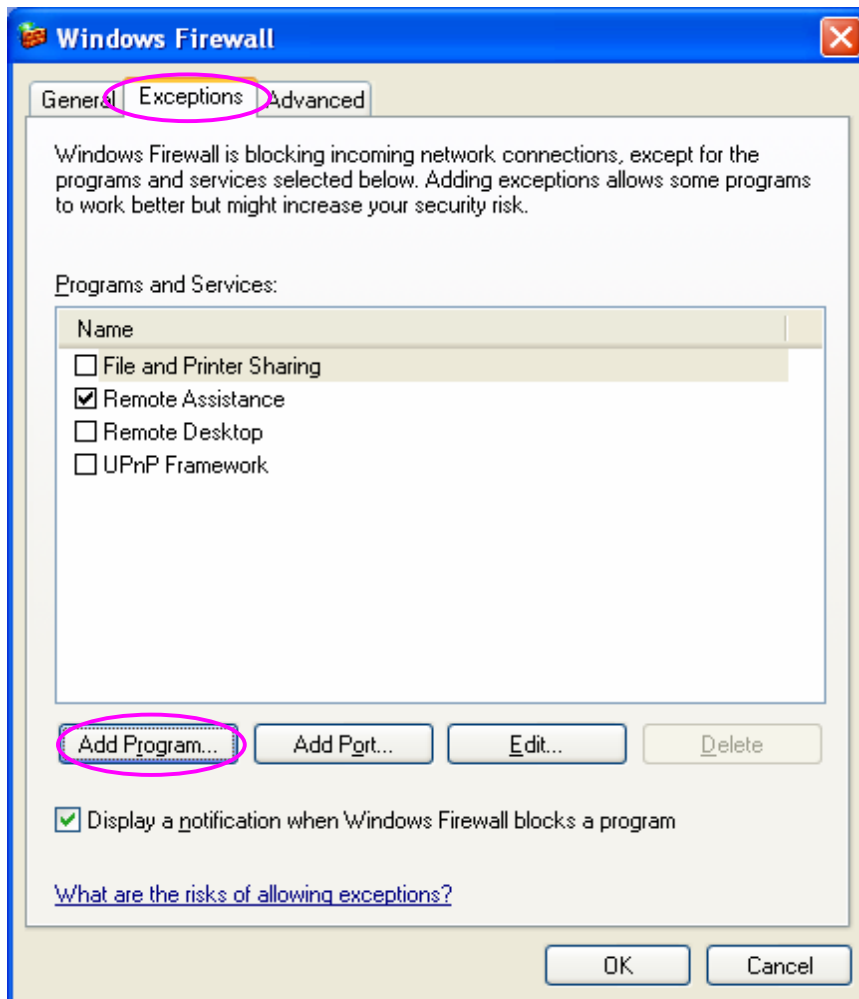

Step5. Click “Browse” to add a new program.

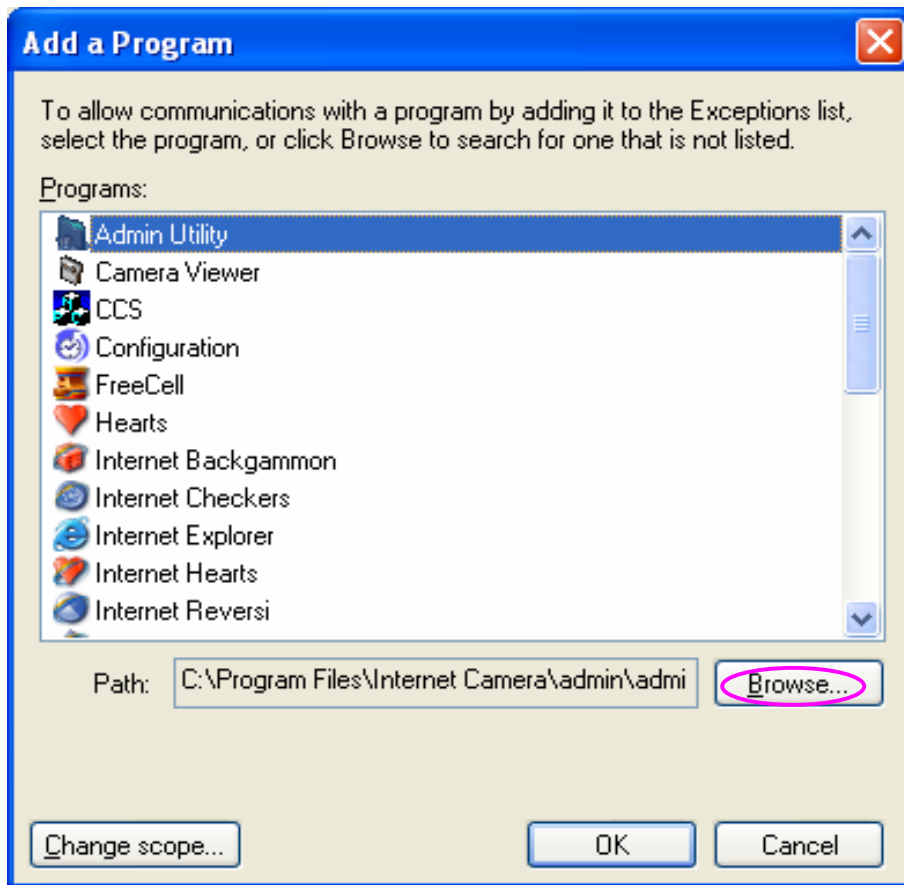

Step6. Open the “NPUtil” file from “C:\Program Files\PrintServer Utilities” (where C:\ is the system drive).

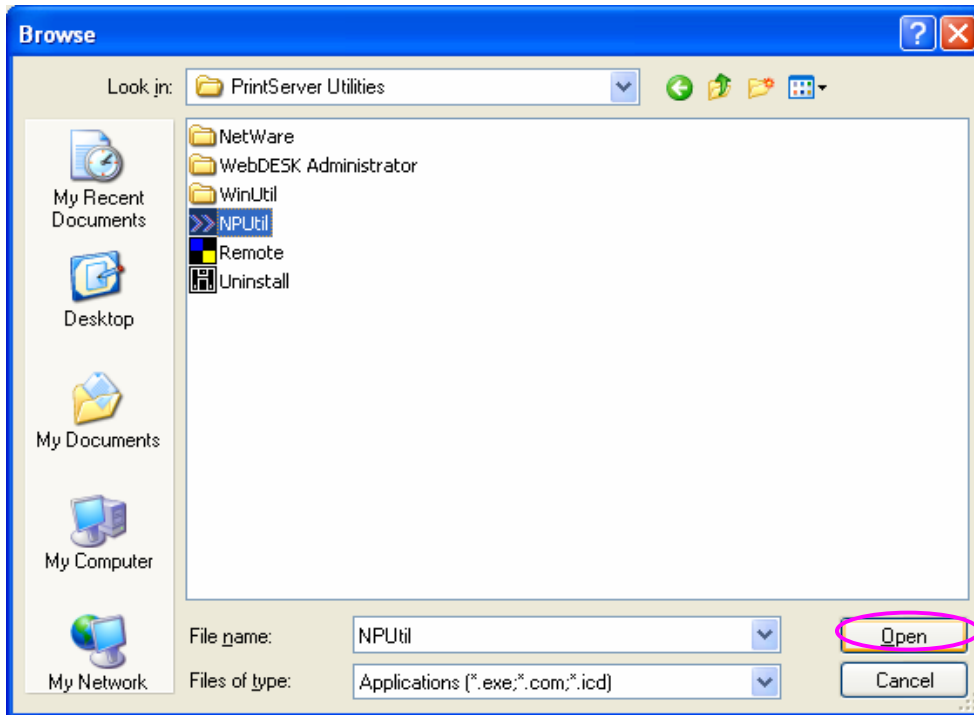

Step7. A new program “Network Ports Quick Setup” is displayed in the list, click “Ok”.

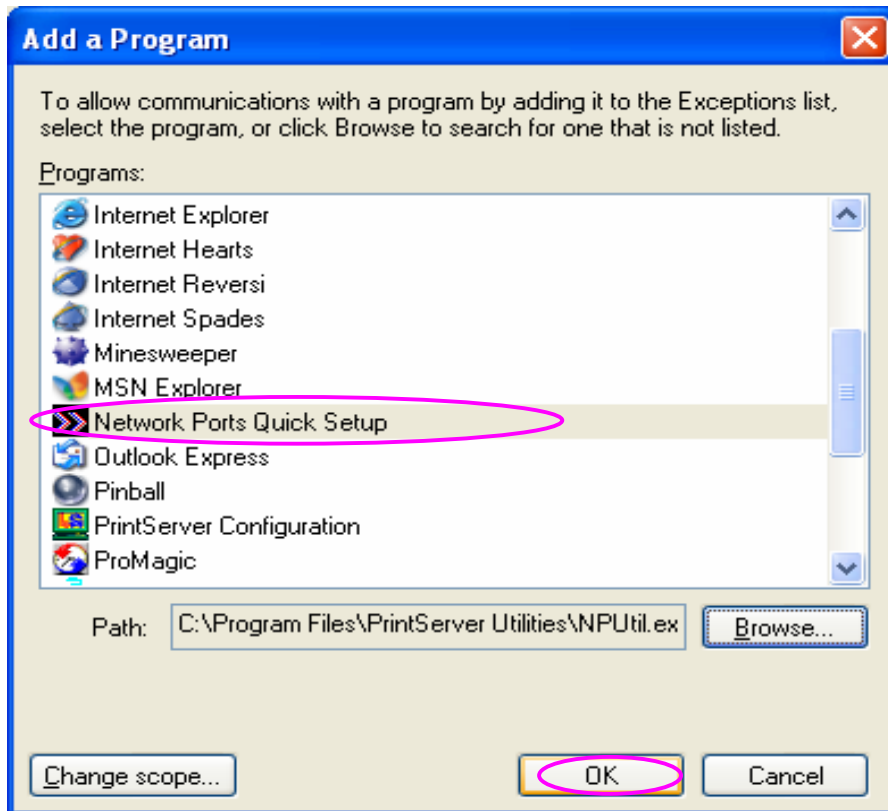

Step8. Click “Ok”. You have completed the setting. The Windows XP SP2 will allow the incoming network connections activated by the program.

